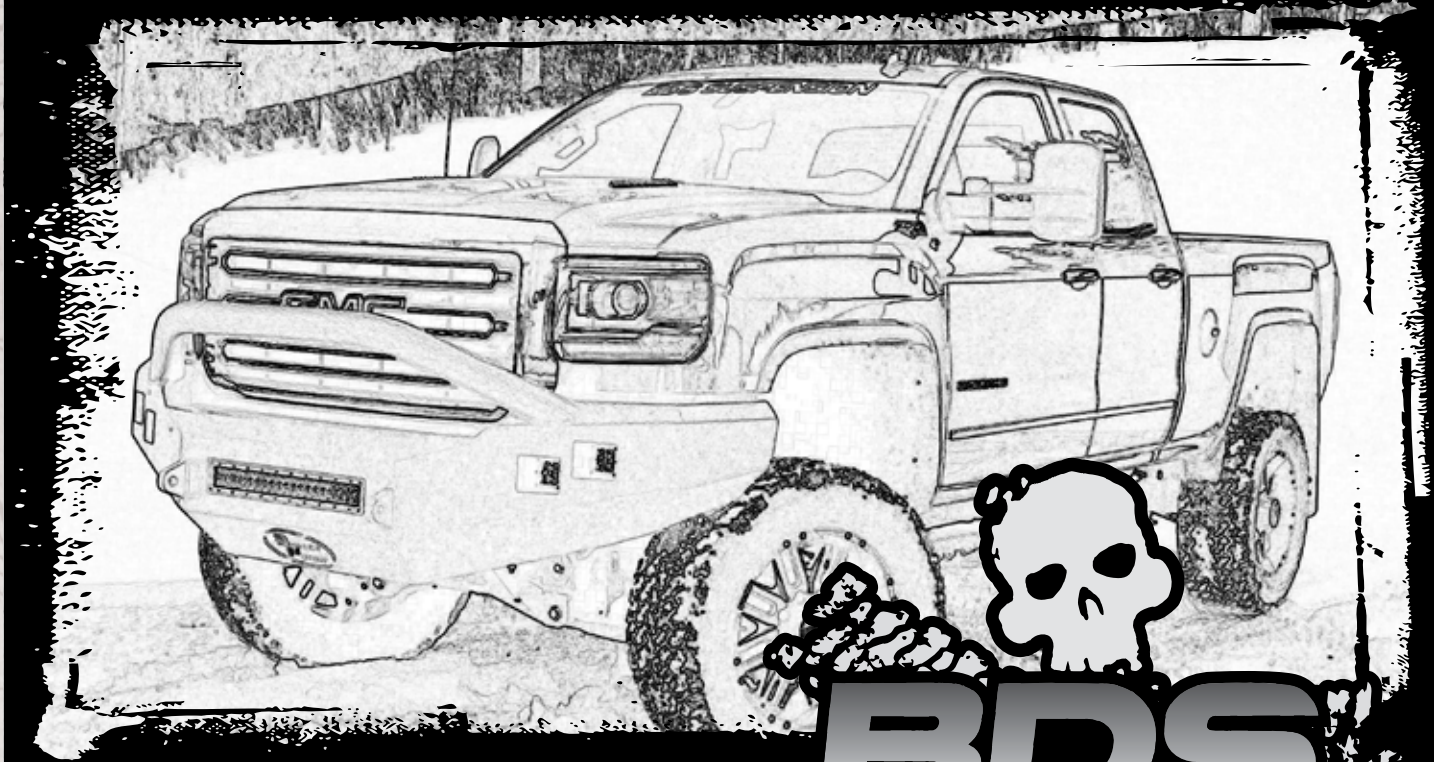
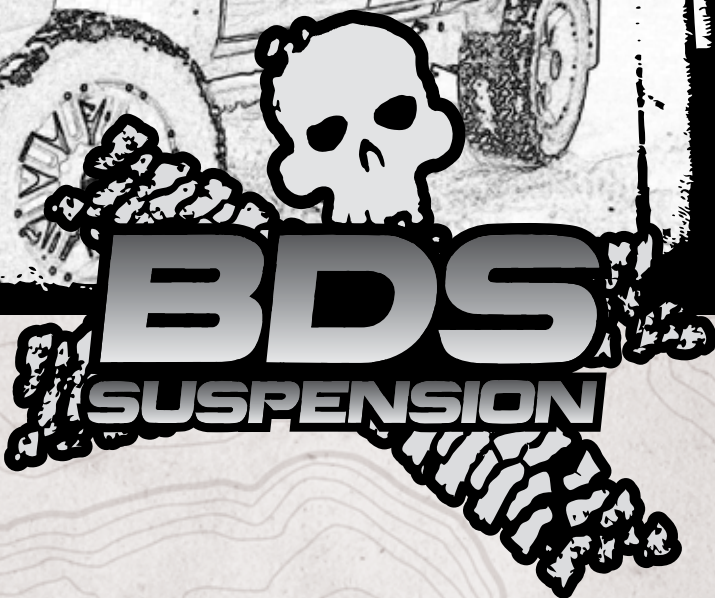


INSTALLATION GUIDE



Part#: 021655



HARDCORE LIMITED LIFETIME WARRANTY

6.5" High Clearance Coilover Suspension System

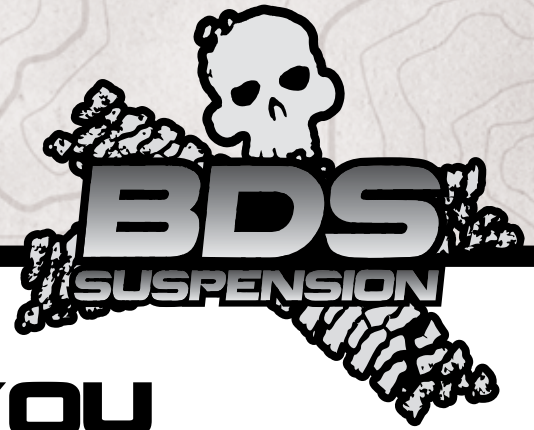
Chevy/GM 2500/3500 HD Pickup 2WD/4WD | 2011-2017

Rev. 030917

491 W. Garfield Ave., Coldwater, MI 49036 • Phone: 517-279-2135

E-mail: tech-bds@sporttruckusainc.com

Read And Understand All Instructions And Warnings Prior To Installation Of System And Operation Of Vehicle.



THANK YOU

Your truck is about to be fitted with the best suspension system on the market today. That means you will be driving the baddest looking truck in the neighborhood, and you'll have the warranty to ensure that it stays that way for years to come. Thank you for choosing BDS Suspension!

BEFORE YOU START

BDS Suspension Co. recommends this system be installed by a professional technician. In addition to these instructions, professional knowledge of disassembly/ reassembly procedures and post installation checks must be known.

FOR YOUR SAFETY

Certain BDS Suspension products are intended to improve off-road performance. Modifying your vehicle for off-road use may result in the vehicle handling differently than a factory equipped vehicle. Extreme care must be used to prevent loss of control or vehicle rollover. Failure to drive your modified vehicle safely may result in serious injury or death. BDS Suspension Co. does not recommend the combined use of suspension lifts, body lifts, or other lifting devices. You should never operate your modified vehicle under the influence of alcohol or drugs. Always drive your modified vehicle at reduced speeds to ensure your ability to control your vehicle under all driving conditions. Always wear your seat belt.

BEFORE INSTALLATION

- Special literature required: OE Service Manual for model/year of vehicle. Refer to manual for proper disassembly/reassembly procedures of OE and related components.
- Adhere to recommendations when replacement fasteners, retainers and keepers are called out in the OE manual.
- Larger rim and tire combinations may increase leverage on suspension, steering, and related components. When selecting combinations larger than OE, consider the additional stress you could be inducing on the OE and related components.
- Post suspension system vehicles may experience drive line vibrations. Angles may require tuning, slider on shaft may require replacement, shafts may need to be lengthened or trued, and U-joints may need to be replaced.
- Secure and properly block vehicle prior to installation of BDS Suspension components. Always wear safety glasses when using power tools.
- If installation is to be performed without a hoist, BDS Suspension Co. recommends rear alterations first.
- Due to payload options and initial ride height variances, the amount of lift is a base figure. Final ride height dimensions may vary in accordance to original vehicle attitude. Always measure the attitude prior to beginning installation.



Visit 560plus.com for more information.

TIRES AND WHEELS

6.5" Kit:

37 x 12.50 on 17" x 9" w/ 4-1/2 to 4-5/8" Backspacing

37 x 12.50 on 18" x 9" w/ 4-1/2 to 4-5/8" Backspacing

37 x 12.50 on 20" x 9" w/ 5 to 5.5" Backspacing

Larger than 20", use 20" wheel specs

Stock 17" and 18" wheels will not fit back on the vehicle once this suspension system is installed. Stock 20" wheels are not recommended.

BEFORE YOU DRIVE

Check all fasteners for proper torque. Check to ensure for adequate clearance between all rotating, mobile, fixed, and heated members. Verify clearance between exhaust and brake lines, fuel lines, fuel tank, floor boards and wiring harness. Check steering gear for clearance. Test and inspect brake system.

Perform steering sweep to ensure front brake hoses have adequate slack and do not contact any rotating, mobile or heated members. Inspect rear brake hoses at full extension for adequate slack. Failure to perform hose check/ replacement may result in component failure. Longer replacement hoses, if needed can be purchased from a local parts supplier.

Perform head light check and adjustment.

Re-torque all fasteners after 500 miles. Always inspect fasteners and components during routine servicing.

CONTENTS OF YOUR KIT

021650-021651

Part #	Qty	Description
02360	1	Steering Knuckle - Drv
02361	1	Steering Knuckle - Pass

021652

Part #	Qty	Description
02362B	1	Front Crossmember
02373B	1	Crossmember Brace
22533D	1	Front Brake Line - DRV
22533P	1	Front Brake Line - PASS
5188	2	Brake Line Clip
590	1	Bolt Pack - Front Brake Lines
	6	Wire Clamp
	4	1/4"-20 x 3/4" bolt
	4	1/4" lock washer
	2	1/4" x 1/2" self-tapping bolt

121650

Part #	Qty	Description
02380B	1	Front Skid Plate

013318/011317

Part #	Qty	Description
3FBB18	2	3" Block
343251350QB	4	3/4x3-1/4x13-1/2 Square U-Bolt (011318 only)
343251550QB	5	3/4x3-1/4x15-1/2 Square U-Bolt (011317 only)
B1225G8	2	12mm-1.75x25mm socket head bolt
N34FLG-B	8	3/4" Serrated Flange Nut

021509/021508

Part #	Qty	Description
5FB18	2	Rear 5" Block w/Wing
02415	2	U-Bolt Plate
344001812RB	4	3/4x4x18-1/2 Round U-Bolt (021508 only)
344001600RB	4	3/4x4x18-1/2 Round U-Bolt (021509 only)
02243	1	E-Brake Tube Extension
SBCA	1	Rear Brake Line Extension
SBTE	1	6mm-1.00 x 95mm Threaded Rod
N34FLG-B	8	3/4" Serrated Flange Nut
588	1	Bolt Pack - Rear
	1	3/8"-16 x 1" bolt
	2	3/8" SAE flat washer
	1	3/8"-16 nylock nut
	1	1/4"-20 x 1" bolt
	2	1/4" USS flat washer
	1	1/4"-20 prevailing torque nut
	1	6mm-1.00 coupler nut
	2	6mm-1.00 hex nut

BDS 121653

Part #	Qty	Description
02834	1	Coilover Conversion - Upper Mount - DRV
02835	1	Coilover Conversion - Upper Mount - PASS
02912	1	Weld-in Support Gusset - DRV
02913	1	Weld-in Support Gusset - PASS
02838	1	Coilover Conversion - Reservoir Mount - DRV
02919	1	Coilover Conversion - Reservoir Mount - PASS
911109	2	Sway Bar Link
SB35BK	2	Wide Eb1 Bushing
SB26RB	4	Sway Bar Link Stem Bushing
54587	2	3/4" OD x 1.575" x 9/16" ID Sleeve
B14X34G5	2	1/4"-20 x 3/4" Self-tapping Bolt CZ
099000	2	Zip Tie
954	1	Bolt Pack - Mounting Hardware
	2	1/2"-13 x 1-1/4" Bolt
	4	1/2"-13 x 1-1/2" Bolt
	2	1/2"-13 x 3-1/4" Bolt
	2	1/2"-13 x 4-1/4" Bolt
	20	1/2" SAE Thru-Hardened Washer
	10	1/2"-13 Prevailing Torque Nut
955	1	Bolt Pack - Sway Bar Links
	2	7/16"-14 Nylock Nut
	4	7/16" USS Washer
	2	9/16"-12 x 3" Bolt
	4	9/16" SAE Thru-hardened washer
	2	9/16"-12 Prevailing Torque Nut

BDS 021655 Box Kit

Part #	Qty	Description
02363b	1	Rear X-Member
02369b	1	Diff Bracket - DRV
02371b	1	Diff Bracket - PASS
02370b	1	Diff Bracket - Center
02372b	1	Diff Skid Plate
585	1	Bolt Pack
	2	18mm-2.50 x 120mm Bolt
	2	18mm-2.50 x 140mm Bolt
	4	18mm-2.50 Prevailing Torque Nut
	8	3/4" SAE Flat Washer
586	1	Bolt Pack
	6	1/2"-13 x 1-1/4" Bolt
	2	1/2"-13 x 1-1/2" Bolt
	2	1/2"-13 x 3-1/2" Bolt
	4	1/2"-13 Prevailing Torque Nut
	12	1/2" SAE Flat Washer
	4	1-3/8"OD x 1/2"ID x 3/16" Thick Washers
	2	12mm-1.75 x 40mm Bolt
	1	9/16"-12 x 4" Bolt
	1	9/16"-12 Prevailing Torque Nut
	2	9/16" SAE Flat Washer
	4	10mm-1.50 x 40mm Bolt
	4	10mm Flat Washer
70	1	0.875 x 0.120 x 2.60 Diff Sleeve

BDS 121653 (CONT'D)

Part #	Qty	Description
02390b	2	Rear Bump Stop Extension
02391B	2	Front Bump Stop Extension
02392	2	Nut Tab
95105A169	3	1/2" Rivet Nut
95105A159	3	3/8" Short Rivet Nut
95105A168	3	3/8" Tall Rivet Nut
593	1	Bolt Pack - Bump Stop Hardware
	2	3/8"-16 x 1" Bolt
	4	3/8"-16 x 1-1/4" Bolt
	1	3/8"-16 x 1-1/2" Bolt
	6	3/8" Lock Washer
	6	3/8" USS Flat Washer
	1	3/8" Star Washer External Tooth
	1	7/16"-20 Hex Nut
	1	1/2" Star Washer External Tooth
	2	1/2"-13 x 2" Bolt
	2	1/2" SAE Flat Washer
	2	1/2" Lock Washer

1. Disassembly/assembly of the factory torsion bar system requires the use of a special unloading tool. The GM specified tool # is CH48809.
2. Some minor trim will be required with certain wheel/tire combination. This is normal with most aftermarket tire/wheel fitment on Chevy/GM trucks. Trimming will normally include the bottom edge of the inner fender shrouds and/or lower corner of front bumper valance. As a rule of thumb, deeper backspacing and shorter/narrower tires will reduce/eliminate trimming required. Further trimming tips are included at the end of this instruction sheet.
3. Coilover Coil has a large amount of preload, a coil spring compressor must be used to remove the coil from the coilover. Failure to use a coil spring compressor may result in death or injury.



**TECH
TIPS**

INSTALLATION INSTRUCTIONS

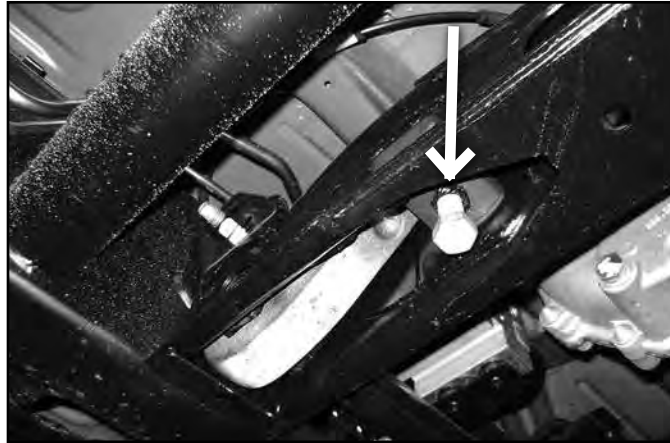
SPECIAL TOOLS

1-1/2" (38mm) socket/wrench
34mm socket
T30 Torx bit
1-1/16" (27mm) socket/wrench
Torsion Bar Unloading tool (see Pre-Installation Note #2)
Reciprocating Saw
4" Cut-off Wheel/Tool (optional)
Pair of Large (8-10") C-Clamps

FRONT INSTALLATION

1. Park the vehicle on a flat, clean surface and block the rear wheels for safety.
2. Welding is required. Disconnect the battery (batteries). Failure to do so can cause electronic damage to the vehicle.
3. Raise the front of the vehicle and support with jack stands under the frame rails.
4. Remove the wheels.

FIGURE 1



5. Unload the torsion bars but do not remove. Remove and save adjuster bolt/retainer block. (Fig 1)



Tip Torsion bars are under extreme pressure. A proper torsion bar tool is necessary to unload the bars. A tool designed specifically for GM torsion bars is required see troubleshooting notes.

6. Remove the torsion bar adjuster plate by pushing the torsion bar forward to allow the plate to drop free. On some vehicles this will require using a hammer/punch or air hammer. Access the end of the torsion bar through the hole in the back of the torsion bar crossmember and drive forward. Leave the torsion bars in the lower control arms.
7. Remove the two bolts that attach the torsion bar crossmember to the frame rails (Fig 2A). Remove the torsion bar crossmember from the vehicle. Save bolts and crossmember. On diesel models, disconnect the wire on the passenger's side of the crossmember before removing (Fig 2B)

FIGURE 2A

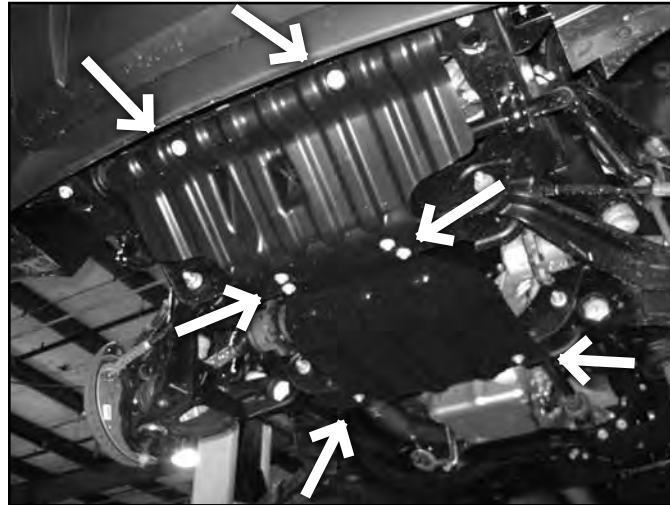


FIGURE 2B



8. Remove the torsion bars by pulling them rearward out of the lower control arms. Set the torsion bars aside.
9. Remove the front plastic splash guard, save splash guard bolts. If equipped, remove the four bolts mounting the factory belly pan to the frame (Fig 3) These will not be reused.

FIGURE 3



10. Disconnect the sway bar end links from the sway bar and the lower control arms (Fig 4A). Discard the link assemblies.
11. Disconnect the tie rod ends from the steering knuckles (Fig 4A). Remove the tie rod end nuts and save. Strike the knuckle near the tie rod end to dislodge the tie rod end taper (Fig 4B). Remove the tie rod ends from the knuckles.

FIGURE 4A

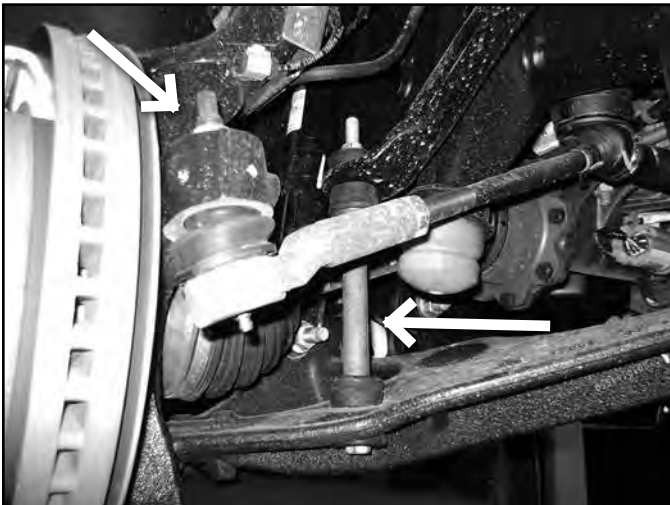


FIGURE 4B



12. Disconnect the ABS brake wire from the connector at the frame (Fig 5) Remove the wire from the plastic retainers on the frame and brake line bracket on the steering knuckle (Fig 6).
13. Disconnect the rubber brake line bracket from the steering knuckle (Fig 6).

FIGURE 5

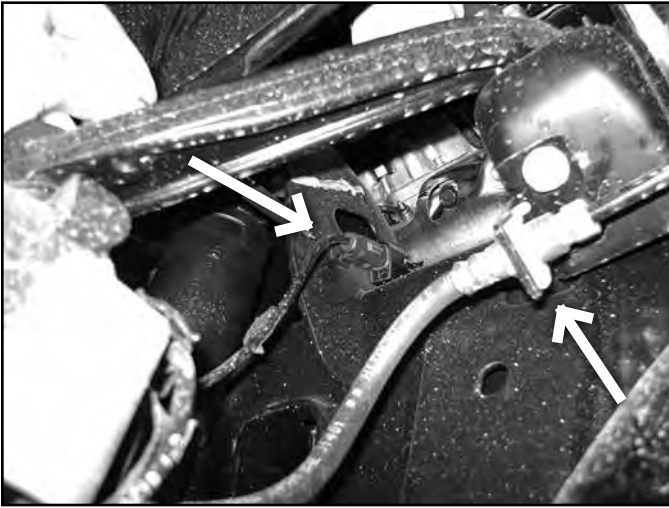
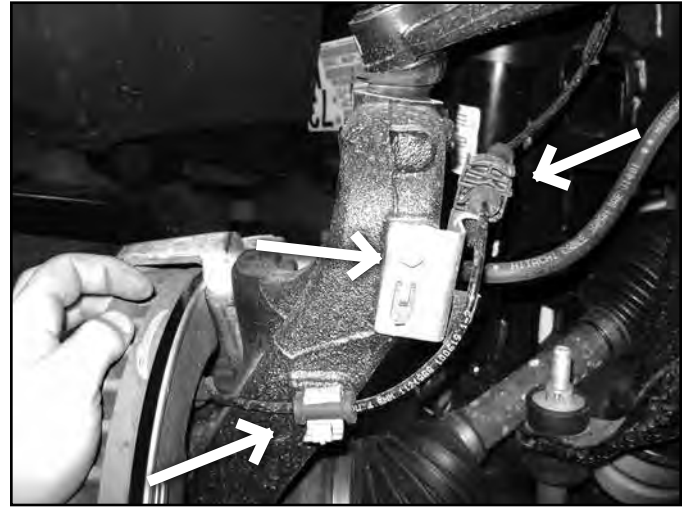


FIGURE 6



14. Remove the two bolts mounting the brake caliper assembly to the steering knuckle and hang the caliper out of the way (Fig 7). Do not hang the caliper by the brake hose. Save mounting bolts.

FIGURE 7



15. Carefully remove the hub dust cover. Save cover (Fig 8). Tip: Carefully work the cover loose with a small chisel.
16. Remove the rotor retaining bolt using a T30 torx bit (Fig 9). Remove the brake rotor and set aside. Save retaining bolt.
17. Remove the CV axle nut and washer (Fig 9). Save hardware.

FIGURE 8

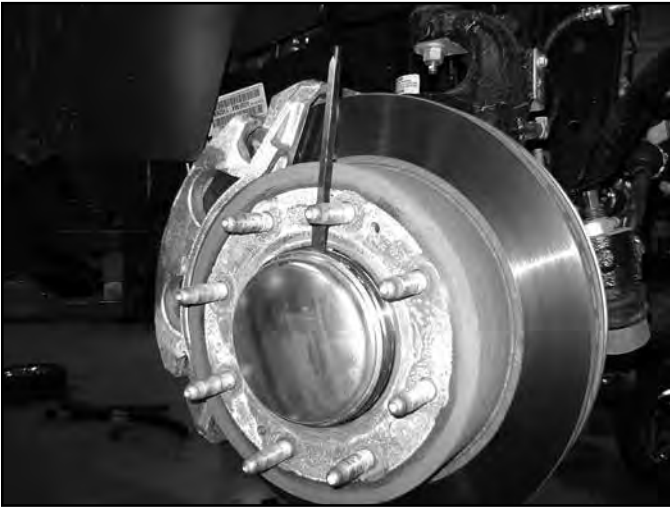
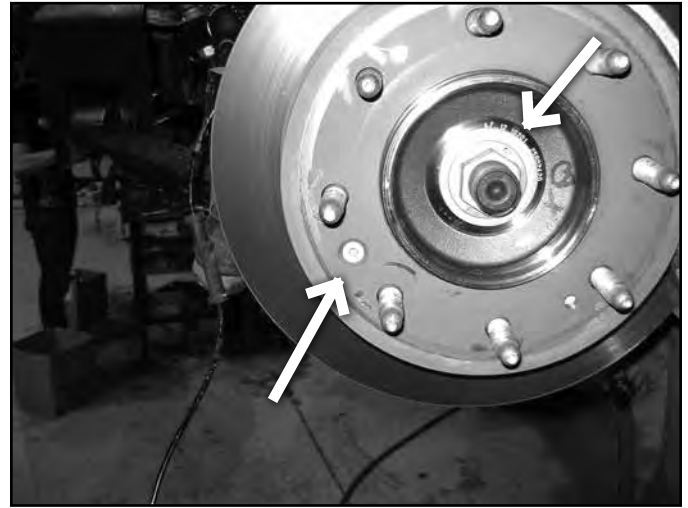
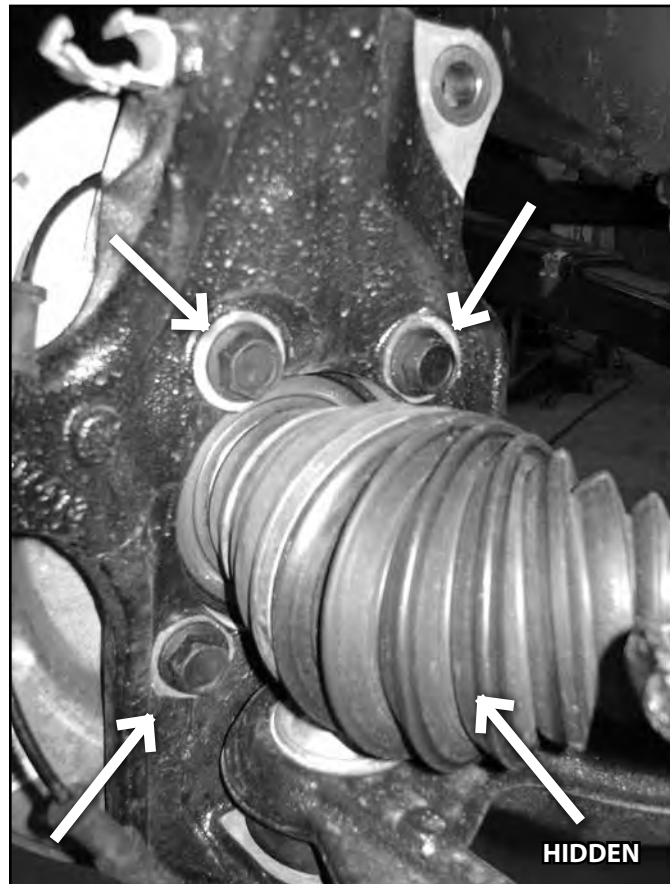


FIGURE 9



18. Locate and remove the four hub bearing assembly bolts (Fig 10). The bolts are accessed from the back side of the steering knuckle. Remove the hub bearing assembly and dust shield from the steering knuckle.

FIGURE 10



19. Remove the upper and lower ball joint nuts (Fig 11). Reinstall the nuts a couple of turns by hand. Strike the knuckle near the ball joints to release the taper. Remove the nuts and remove the steering knuckle from the vehicle. Save nuts. Take care not to strike the ball joint.

FIGURE 11



20. Remove the CV axle flange bolts at the differential (Fig 12). There are 8 bolts per side. Remove the CV shafts from the vehicle and set aside. Save bolts.

FIGURE 12



21. Disconnect the shocks from the frame (Fig 13A) and lower control arm (Fig 13B). Remove shocks. Save the lower shock mount hardware.

FIGURE 13A

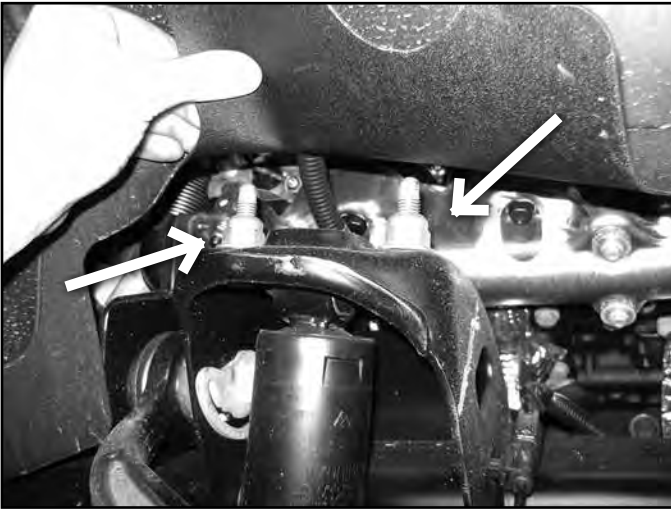
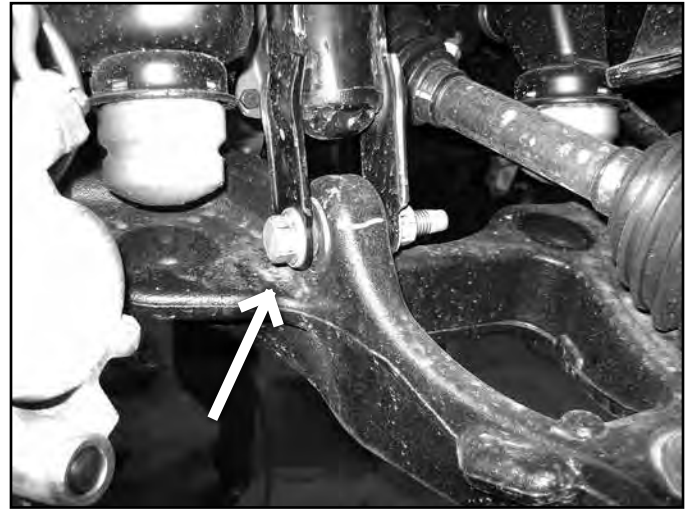


FIGURE 13B



22. Remove the front and rear lower control arm bolts and remove the control arms from the vehicle (Fig 14a) Save the control arms and mounting hardware.
23. Remove the upper control arms from the vehicle. Keep the cam bolts for later reinstallation. (Fig 14b)

FIGURE 14A

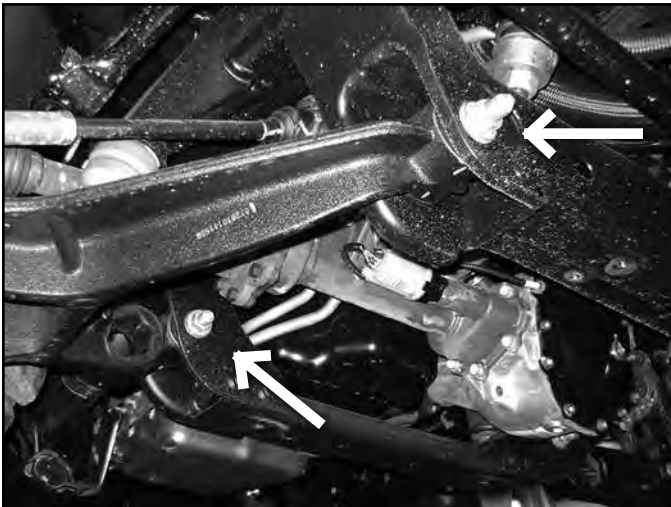


FIGURE 14B



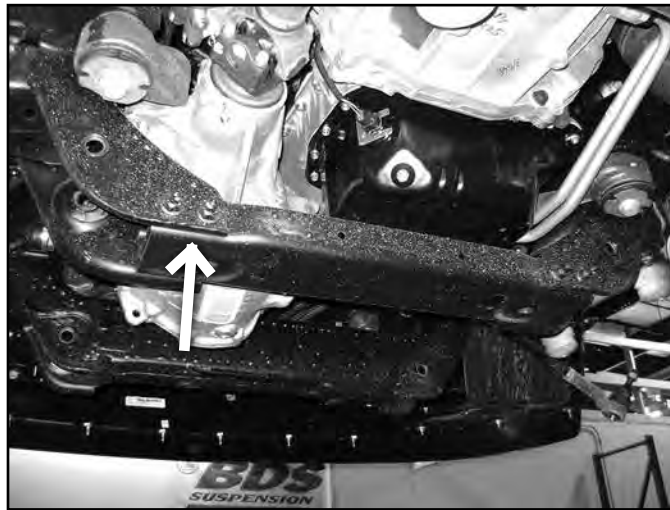
24. There are two factory bump stops per side. Remove the front rubber bumpstop from the frame mounts on each side. They can be removed with a pair of channel-lock pliers.
25. Make an alignment mark on the front driveshaft and front differential input yoke. Remove the four bolts/clamps from the yoke and remove the front driveshaft from the differential (Fig 15). Save the driveshaft hardware.

FIGURE 15



26. Remove the four bolts mounting the rear crossmember to the rear lower control arm pockets (Fig 16). Remove the crossmember from the vehicle. The crossmember and hardware will not be reused.

FIGURE 16



27. Disconnect the electrical connector from the front differential actuator (Fig 17A) Remove the wire from the three plastic wire retainers along the top of the differential.
28. Disconnect the axle breather tube from the top of the driver's side of the differential (Fig 17B).

FIGURE 17A



FIGURE 17B

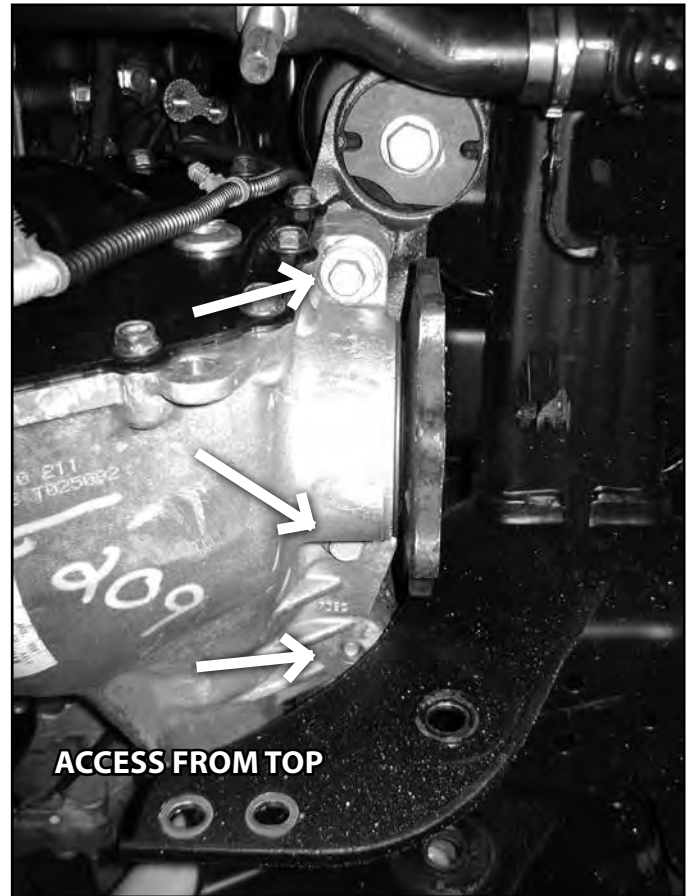


29. Loosen but do not remove all of the front differential mounting bolts/nuts. There are two nuts on the passenger's side (Fig 18A) and three bolts on the driver's side (Fig 18B - two mount from the bottom up and one from the top down). Remove the rear-most bolt mounting from the top.

FIGURE 18A



FIGURE 18B



30. Support the front differential with an appropriate jack. Remove the differential mounting hardware and lower the differential from the vehicle and set aside. Save hardware.

FRAME MODIFICATION:

31. The lower rear driver's side control arm pocket must be trimmed to provide clearance for the front differential. On the front face measure from the center of the control arm mounting hole inward 1-1/4" and mark. Fig. 19A On the back face measure from the center of the control arm mounting hole inward 2-1/2" and mark. Fig. 19B Make vertical cut lines at the marks on the front and back faces. Along the top, connect the front and back cut lines with a diagonal cut. Fig. 19C

FIGURE 19A (FRONT VIEW)



FIGURE 19B (REAR VIEW)

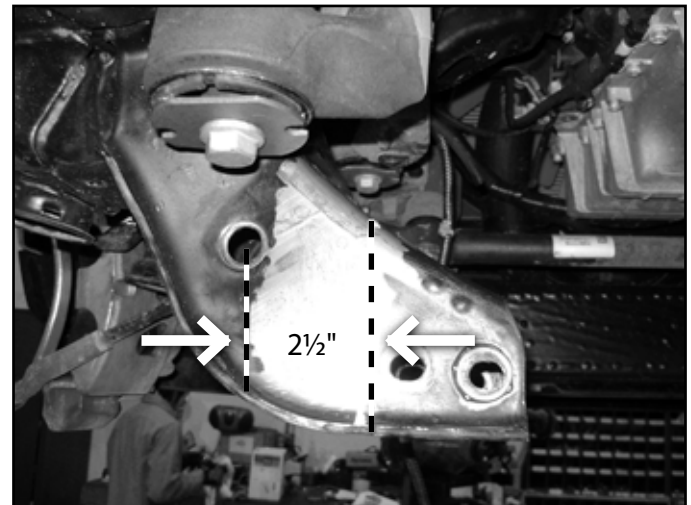


FIGURE 19C

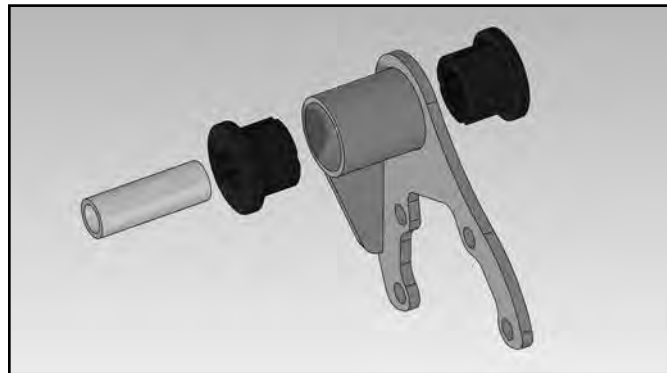


32. Using a reciprocating saw (recommended), hack saw or cut-off wheel, cut the pocket along cut lines. Remove any burrs or rough edges and paint any bare metal to prevent corrosion.

DIFFERENTIAL ASSEMBLY:

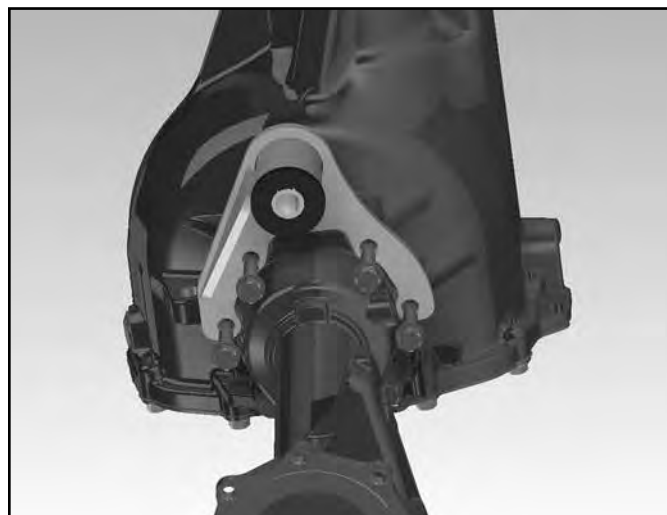
33. Install the provided large bushings (3523) and 0.875" OD x 2.620" long sleeve (70) into the eye of the new center differential bracket (02370) (Fig 20).

FIGURE 20



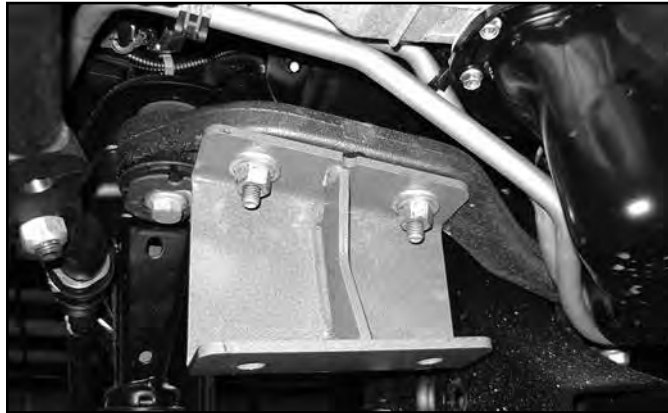
34. Locate the 4 housing bolts to be removed. Remove the four bolts, place the bracket in position and fasten with new 10mm x 40mm bolt and washers (BP 586). The bracket gusset will be toward the bottom of the differential (Fig 21). Use Loctite on the bolt threads and torque to 40 ft-lbs.

FIGURE 21



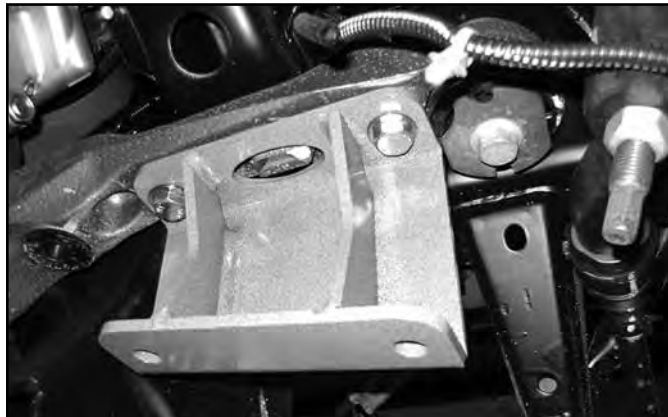
35. Locate the new passenger's side differential bracket (02371). Bracket has a single center gusset. Install the bracket on the existing studs on the passenger's side factory bracket. Fasten with the original nuts and washers. When installed the open side of the bracket will face inward and the bracket will taper down as it goes to the rear (Fig 22). Torque nuts to 65 ft-lbs.

FIGURE 22



36. Locate the new driver's side differential bracket (02369). Bracket has two center gussets. Install the bracket to the 2 front original differential mounting holes with the provided 12mm-1.75 x 40mm bolts and 1/2" SAE washers (BP 586), applying Loctite to the threads before installation. When installed the open side of the bracket will face inward and the bracket will taper down as it goes to the rear (Fig 23). Torque bolts to 65 ft-lbs.

FIGURE 23



37. Using an appropriate jack, raise the differential up into the vehicle. Align the differential mounting holes to the new driver's and passenger's side differential brackets. Fasten to the driver's side mount with 1/2" x 3-1/2" bolts, nuts and 1/2" SAE flat washers (BP 586). Fasten the passenger's side 1/2" x 1-1/2" bolts, nuts and heavy 1/2" (large OD) washers (BP 586). Leave hardware loose.
38. Locate the new rear crossmember (02363). Install the crossmember in the rear lower control arm pockets with the factory control arm bolts/nuts. Run the bolts from rear to front. The center differential bracket will fit into the mount tabs on the crossmember. Fasten the differential mount to the crossmember with a 9/16" x 4" bolt, nut and 9/16" SAE washers (BP 586). Leave hardware loose. (Fig 24)

FIGURE 24



39. With the differential and rear crossmember installed, tighten all the differential mount hardware. Torque the (4) 1/2" bolts to 65 ft-lbs and (1) 9/16" bolt to 95 ft-lbs.
40. Reconnect the front driveshaft to the front differential with the factory clamps and bolts. Torque hardware to 25 ft-lbs.
41. Reconnect the front differential actuator wire. Reattach the wire harness to the housing. Use the provided zip ties where needed. Pull down on the differential breather hose to gain slack and reconnect to the top of the differential.
42. Locate the new front crossmember. Install the crossmember in the front lower control arm pockets and fasten with the original control arm bolts/nuts. Run the bolt from front to rear. Leave hardware loose.

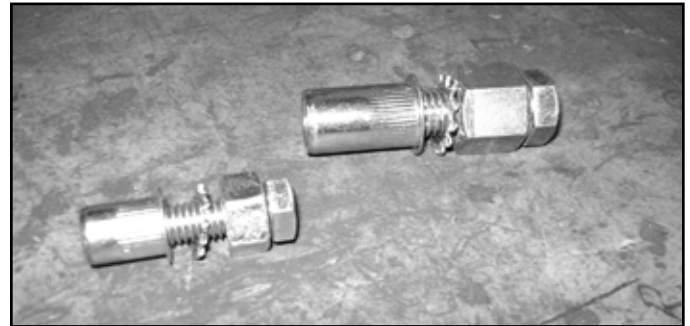
BUMP STOP INSTALLATION:

43. Locate all of the provided rivet nuts and bump stop bolt pack #593. There are 3 each of 3 different rivet nuts sizes are provided, 1/2" (large) and two 3/8" with one set longer than the other. Sort the rivet nuts by size (Fig 25a). Set up the rivet nut installation tools. The 1/2" tool consists of a 1/2" x 2" bolt, 9/16" high nut and 1/2" star washer. The 3/8" tool consists of a 3/8" x 1-1/2" bolt, 7/16" hex nut and 3/8" star washer. Set up the tools as shown (Fig 25b).

FIGURE 25A



FIGURE 25B



44. Six holes need to be slightly clearanced on the factory bump stop mounts to accepted the rivet nuts. For the 3/8" rivet nuts drill the holes to 17/32" and 11/16" for the 1/2" rivet nuts. In both cases, if the necessary bits are not available, a rotary grinding tool can be used to enlarge the holes to the proper size. Take care not to open the holes too much. Drill out the holes shown in (Fig 26a - Front, Fig 26b - Rear)

FIGURE 26A (FRONT BUMP STOP)

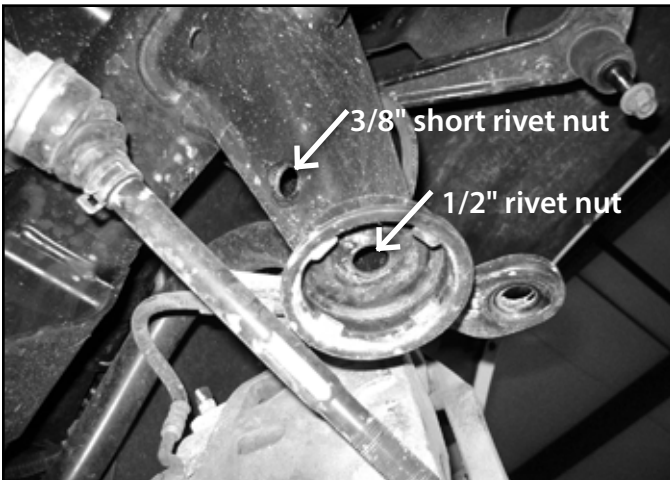


FIGURE 26B (REAR BUMP STOP)

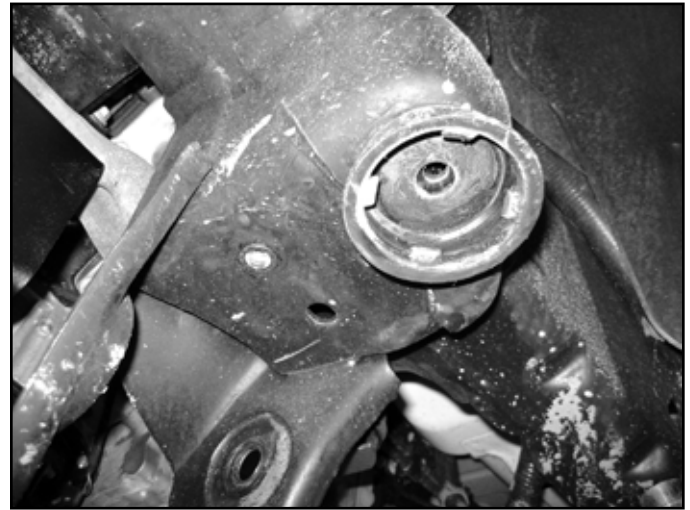


45. Install the rivet nuts. Thread the appropriate rivet nut on the preassembled tool. The longer 3/8" rivet nut will be installed in the rear bump stop mount. The 1/2" rivet nut goes in the center of the factory front bump stop cup. Insert the rivet nuts into the holes. Hold the jam nut with a wrench and tighten the bolt to collapse the rivet nut in the hole (Fig 27a). Be sure to hold the rivet nut tight and flush in the hole. Take care not to over tighten. The 3/8" rivet nut can be tighten to approximately 40-45ft-lbs and the 1/2" to approximately 90 ft-lbs. Reuse the tools to install all six rivet nuts (Fig 27b). For detailed rivet nut installation instructions see the end of this instruction sheet.

FIGURE 27A

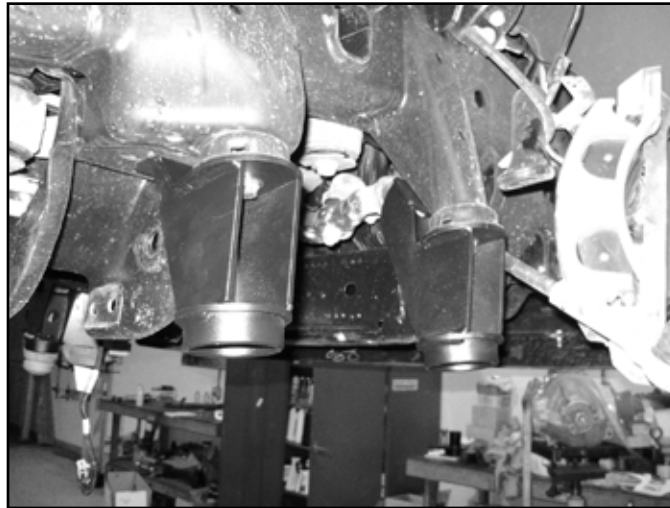


FIGURE 27B



46. With all the rivet nuts installed, locate the provided front bump stop brackets. Attach the front brackets to the factory bump stop mount with a 1/2" x 2" bolt, flat washer and lock washer (use the installation bolt for one of the brackets). Fasten the back of the mount with a 3/8" x 1-1/4" bolt, flat washer and lock washer. Torque the 3/8" hardware to 30 ft-lbs and 1/2" hardware to 60 ft-lbs (Fig 28).

FIGURE 28



47. Locate the rear bump stop brackets and two nut plates. Install the nut plates in the factory bump stop cups so the tabs point down and lock in place against the tabs in the cup (Fig 29). Attach the bump stop bracket to the factory mount with a 3/8" x 1" bolt, flat washer and lock washer into the nut plate. Snug hardware. Fasten the back tab of the bracket to the rivet nut with a 3/8" x 1-1/4" bolt, flat and lock washer. Torque 3/8" hardware to 30 ft-lbs.

FIGURE 29



48. Install the factory bump stops into the new mounts. Place the bump stops in the new cups at an angle and twist them into the cups (Fig 30).

FIGURE 30



CONTROL ARM AND COILOVER INSTALLATION

49. Prep the area by the upper shock mount for welding. Remove the GM undercoating in this area. Using brake clean with a putty knife is the easiest way to remove large chunks of the undercoating.
50. Place the weld-in support plate against the factory brackets. Ensure area is properly prepared for welding. Weld plate with appropriate mig or tig welder, certified welder highly recommended. (Fig 31a, 31b)

FIGURE 31A

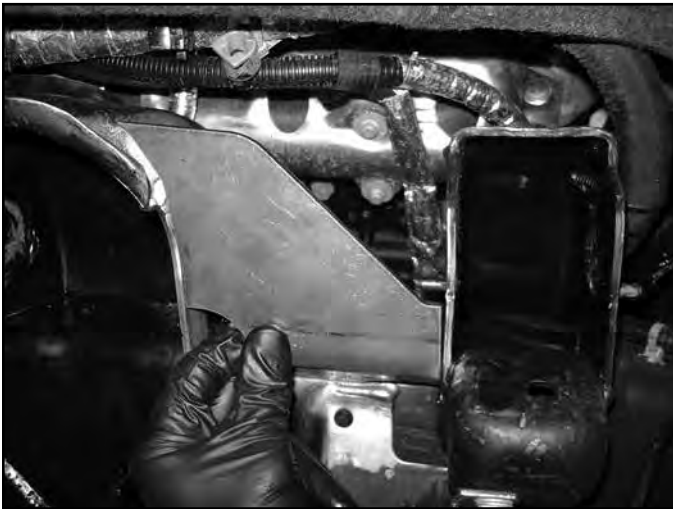


FIGURE 31B



51. Allow plate to cool, coat bare metal with paint.
52. Install the upper control arms at this time (#02836 - DRV, #02837 - Pass). Use the factory cam bolts, washers, and nuts. Do not torque to specification at this time. Center the cams and snug hardware.
53. Place the upper coilover bracket against the factory shock mounting bracket. Mark center of the lower slot and drill out to 1/2". Driver's side will be an existing hole that needs to be enlarged. (Fig 32a, 32b)

FIGURE 32A



FIGURE 32B



54. Install the upper coilover bracket with 1/2" x 1-1/2" hardware through the original upper mount, attach the reservoir bracket to the top side. Attach lower hole with 1/2" x 1-1/4" hardware (BP # 954) . Tighten to 65 ft-lbs.
55. Install the coilover at this time. Attach to the upper bracket with 1/2" x 3-1/4" hardware.



Tip *Fitting will face towards the FRONT of the vehicle. (Fig 33a, 33b)*

56. Route the reservoir hose BEHIND the brakeline bracket. The brakeline bracket will need to have a new hole drilled on the upper control arm droop limiter, drill to 7/32" and attach with included 1/4" self threading bolts. Attach the reservoir hose to the original brakeline bracket mounting hole with factory hardware and new 7/8" clamp.

FIGURE 33A

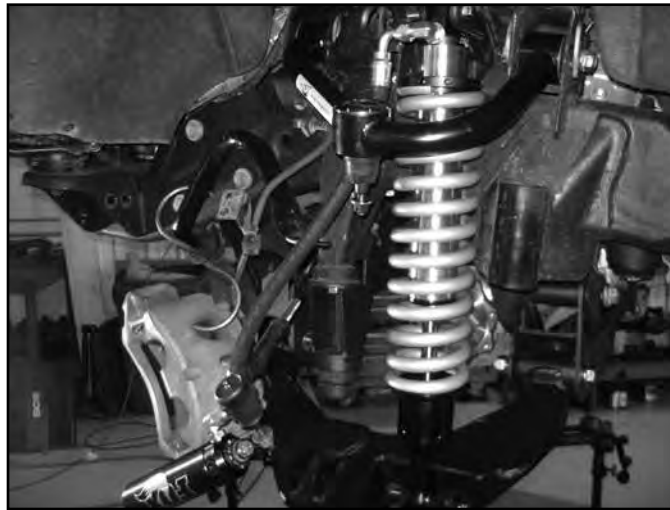


FIGURE 33B



57. Install new lower control arms with 18mm hardware from bolt pack 585. Do not tighten the hardware at this time.
58. Attach the lower control arm to the lower coilover mount with 1/2" x 4-1/4" hardware. (Fig 34)

FIGURE 34



DIFFERENTIAL SKID PLATES:

59. Locate the new differential skid plate (02372). Position the skid plate so that it aligns to holes with the welded nuts on the bottom driver's side of the rear crossmember (Fig 35a). Fasten the skid plate with 1/2" x 1-1/4" bolts and 1/2" SAE washers (BP 586). Snug hardware so the front of the skid plate sets up near the bottom of the front crossmember.
60. Locate the new crossmember support brace (02373). The brace is formed to clear the differential actuator when installed. Position the support brace so it sets properly against the bottom of the front and rear crossmembers and aligned to the mounting holes. Fasten the tube to the rear crossmember with a 1/2" x 1-1/4" bolt and 1/2" SAE washer (BP 586). Again, snug hardware so the brace sets up near the bottom of the front crossmember (Fig 35a).
61. Locate the new front "BDS" skid plate/splash guard (02380). Loosely attach the skid plate to the original splash guard mounting holes on the upper frame crossmember using the original splash guard bolts. (Fig 35b) Position the skid plate up to the bottom of the front crossmember "sandwiching" the support brace and differential skid plate. Fasten the front skid plate, differential skid plate and support tube to the front crossmember with 1/2" x 1-1/4" bolts and 1/2" SAE washers (BP 586) in the welded nuts in the crossmember (Fig 28B). Apply Loctite to the bolt threads and torque to 55 ft-lbs.
62. With the front hardware tight, remove the rear bolts one at a time and apply Loctite to the threads. Reinstall and torque to 55 ft-lbs. Torque the front factory splash guard bolts to 25 ft-lbs.
63. After all the skid plate hardware is tight, go back and torque the 4 factory lower control arm pocket bolts (mounting the new crossmembers) to 250 ft-lbs. Do not tighten the lower control arm hardware at this time. It will be done with the weight of the vehicle on the ground.

STEERING KNUCKLE:

64. Locate the new steering knuckles and identify the driver's and passenger's side. Install the appropriate knuckle on the lower control arm and fasten with the original lower ball joint nut. Swing the knuckle up and attach to the upper ball joint with the original nut. Torque the upper ball joint nut to 37 ft-lbs and the lower ball joint nut to 74 ft-lbs (Fig 36).

FIGURE 35A



FIGURE 35B



FIGURE 36



65. Locate the hub o-ring in the factory steering knuckle hub bores. Carefully remove the o-rings (Fig 37) and install into the new steering knuckles.

FIGURE 37



66. Locate the factory CV axle shafts. Install the CV axle so that it fits through the knuckle, (Fig 38) and then onto the differential output flange. Align the differential flange holes and fasten with the factory bolts. Apply Loctite to the threads and torque to 40 ft-lbs.

FIGURE 38



67. Locate the factory driver's and passenger's brake dust shields. They need to be modified to provide adequate brake caliper clearance. Make a cut line by following the straight edge on the caliper side of the shield all the way to the bottom edge of the shield. (Fig 39) Cut the shield along the line.

FIGURE 39



68. Install the hub assembly and dust shield into the appropriate steering knuckle. The ABS line will run out the top of the hub and behind the dust shield. (Fig 40) Fasten the hub to the knuckle with the factory bolts. Apply Loctite to the threads and torque the bolts to 125 ft-lbs.

FIGURE 40



69. Run the ABS line around the front of the steering knuckle and up to the wire connector on the frame. Reconnect the wire and reattach it to the original place on the frame.
70. Reinstall the torsion bar crossmember in the frame with the original mounting bolt. Torque bolts to 90 ft-lbs. On diesel models, reconnect the factory wiring that was disconnected during disassembly (Fig 2B - beginning of instruction sheet).
71. Install the original CV axle nut and washer and torque to 155 ft-lbs. Reinstall the hub dust cap.
72. Install the brake rotor on the hub by aligning the tapered retainer bolt hole in the rotor with the threaded hole in the hub flange. Fasten the rotor to the hub with the original retainer bolt and tighten securely with a T30 torx bit.
73. Locate the factory brake line junction at the frame where the hardline and rubber line meet. (Fig 5) Using a 13mm line wrench disconnect the hardline from the rubber line. Remove the retaining clip and pull the line from the frame bracket. Place a bucket, etc under the hardline to catch any brake fluid drips. Do not allow excessive fluid to escape or a trip to the dealership for ABS module recalibration may be required.
74. With the brake lines free, install the brake calipers on the knuckles with the original bolts. Apply Loctite to the bolt threads and torque the bolts to 125 ft-lbs.
75. Locate the new provided stainless steel brake lines (22533D/P). The lines are driver's and passenger's side specific. The caliper end has a offset jog. When install the hardline at the caliper will offset towards the inside of the vehicle. Identify the appropriate lines. (Fig 41 - Pass Side Shown)

FIGURE 41



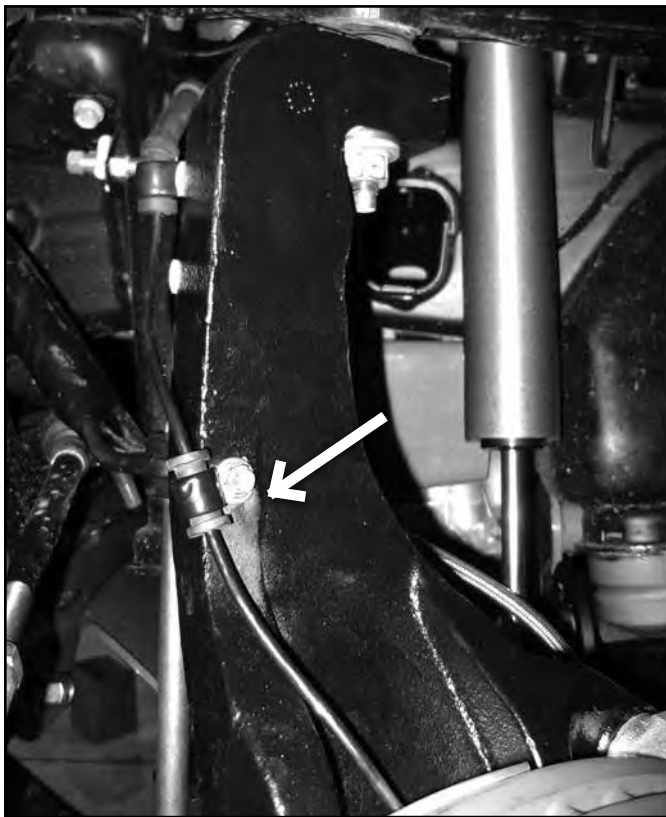
76. Remove the factory brake line from the caliper. Be sure to remove the factory crush washers as well. Place a new provided crush washer on each face of the new brake line and install on the caliper with the factory banjo bolt. Torque the bolt to 20 ft-lbs.
77. Run the new brake line up to the factory frame mount bracket. Feed the end of the line through the bracket and fasten to the factory hardline. Using a 13mm line wrench on the hard line fitting and 11/16" wrench on the new line, tighten the fitting securely. Secure the line to the factory bracket with the original brake line clip or the provided new one (5188). (See step 33b for routing information)
78. There are two threaded holes near the top of the steering knuckle neck on the back side. Using a provided wire clamp, 1/4" x 3/4" bolt and 1/4" lock washer (BP 590) loosely fasten the brake line to the lower threaded hole on the steering knuckle. Using the same fastener combination, attach the ABS line to the upper threaded hole. The hardware will be tightened once the line slack is set. (Fig 43A). Ensure there is adequate clearance between the brakeline and reservoir hose at full droop. Adjust accordingly, it may be necessary to deform the clamp slightly to hold the brakeline in place to keep it from sliding in the clip.

FIGURE 43A



79. On the front side of the steering knuckle there is a small threaded hole. Using a third wire clamp, fasten the ABS wire to the front face of the knuckle with a 1/4" x 1/2" self-tapping bolt (BP 590). Tighten securely. (Fig 44) Adjust the slack in the two other lines, rotating the steering knuckle back and forth as a check, and tighten the upper two clamps to 10 ft-lbs.

FIGURE 44



80. Locate the new front sway bar links (911109), hourglass bushings (SB35BK) and 3/4" OD X 1.575" steel sleeves (54587). Lightly grease and install the bushings and sleeves into the sway bar link ends.
81. Install the new sway bar links into the new lower control arms with 9/16" hardware. Leave bolts loose. Install a provided 7/16" washer followed by a stem bushing. Install the link end into the sway bar end and fasten with a second stem bushing, 7/16" washer and 7/16" nylock nut (BP 955). Tighten the 7/16" nut just until the stem bushings begin to swell. (Fig 45) Torque the 3/8" hardware to 30 ft-lbs.

FIGURE 45

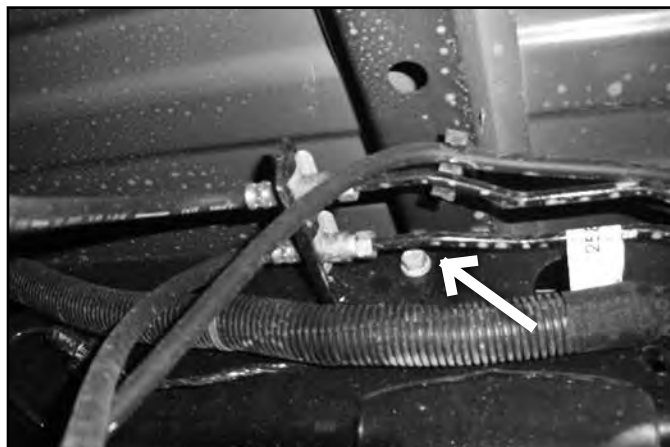


82. Attach the tie rod ends to the knuckles. The tie rod end with mount from the top down. Fasten with the original nuts and torque to 44 ft-lbs.
83. Install the front wheels. Torque the lug nuts to 140 ft-lbs. Lower the vehicle to the ground.
84. Bounce the front end to settle the suspension.
85. Torque the lower control arm bolts (4) to 250 ft-lbs.
86. Check all front hardware for proper torque.
87. Grease the upper and lower ball joint. Lightly grease the o-ring and install on the upper ball joint cap. Press the cap in squarely to seat. Cap must be removed at maintenance intervals to grease the upper ball joint.
88. Properly bleed the entire brake system. Top off fluid. Check all brake lines for proper clearances. Adjust as necessary.
89. Check tire/wheel clearance with the fenders/bumper as well as with the steering knuckle. It is not uncommon to trim the lower plastic valance of the bumper and inner fender shroud slightly to add proper tire clearance while turning.
90. Check the reservoir hose and brakeline for adequate clearance. Adjust as necessary.

REAR INSTALLATION

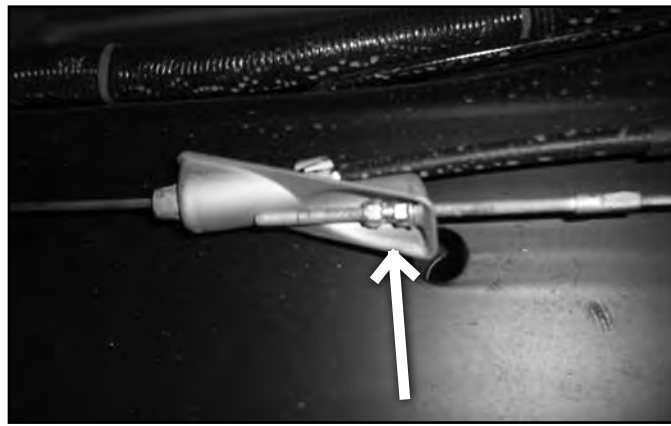
1. Block the front wheels for safety. Raise the rear of the vehicle and support with jack stands under the frame rails, just ahead of the front leaf spring hangers.
2. Remove the wheels.
3. Raise rear of vehicle and support frame with jackstands.
4. Support the rear axle with a hydraulic jack.
5. Disconnect brake line from inside the driver's side frame rail. Save hardware. (Fig R1)

FIGURE R1



6. Disconnect the emergency brake line from the junction block in front of the rear leaf spring hanger. (Fig R2)

FIGURE R2

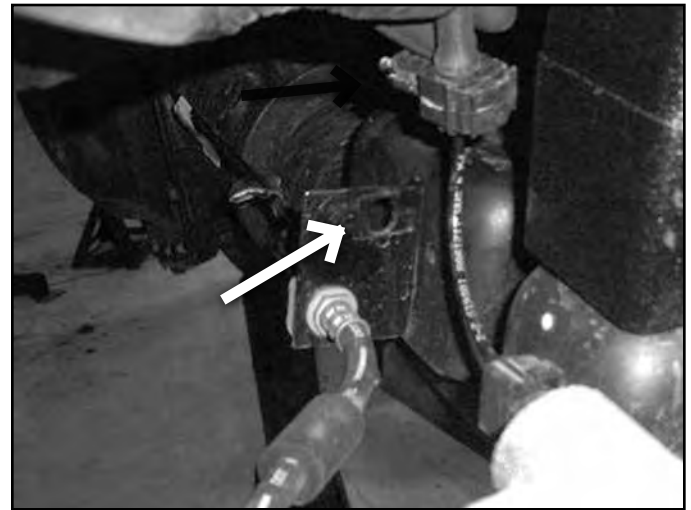


7. Disconnect the E-brake cable bracket from the frame near the rear jounce bumper. Save hardware, it will be reinstalled later. (Fig R3)
8. Push the ABS wire clips from the metal tabs just inside of the leaf springs. Remove the plastic clips from the ABS wire.(Fig R4)

FIGURE R3



FIGURE R4



9. Remove the rear shocks. Save hardware.
10. With the axle well supported, remove the passenger's side u-bolts and lower u-bolt plate. Loosen, but do not remove the u-bolt hardware on the driver's side. This will allow the axle to move more easily and aid in installation.
11. 3" & 5" Rear Block Kit Only: Clamp the leaf spring pack with c-clamps and remove the upper u-bolt retaining plate by removing the center pin nut. Reinstall and tighten the center pin nut to 35 ft-lbs. Loosely place the new u-bolt plate (02374) on top of the leaf spring. The plate will use the rear most hole to go around the center pin nut. (Fig R5a, R5b)

FIGURE R5A

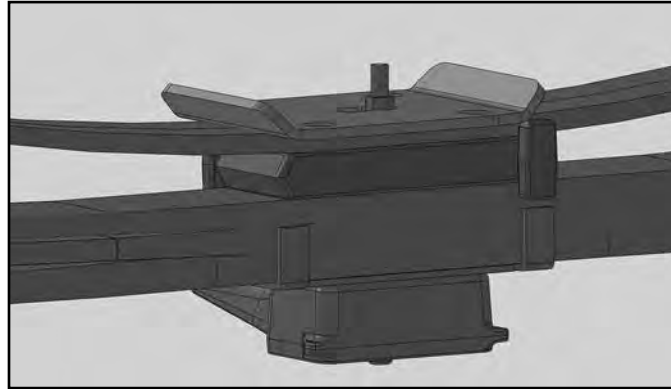


FIGURE R5B



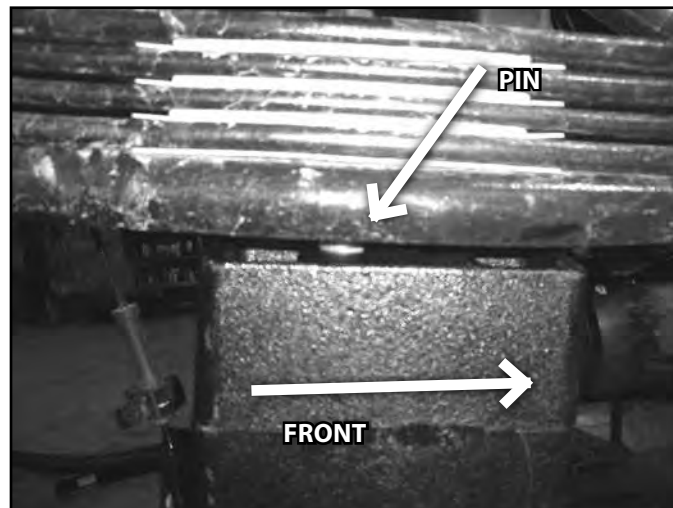
12. 3" & 5" Overload options: The Models equipped with overload leaves will need the separation block modified. Trim the anti-rotation tabs from the front side of block on both the inside and outside of the block. Use extreme care near the fuel tank, do not use any method that will create sparks if the block is not removed when modified. A sawzall is highly recommended. (Fig R6)

FIGURE R6



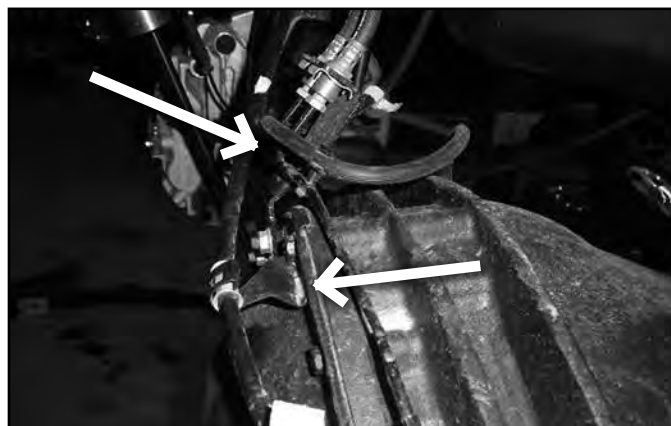
13. Lower the axle to allow the lift block (5FB18) to be installed. The leaf spring pin will go in the REAR hole of the block. (Fig R7)

FIGURE R7



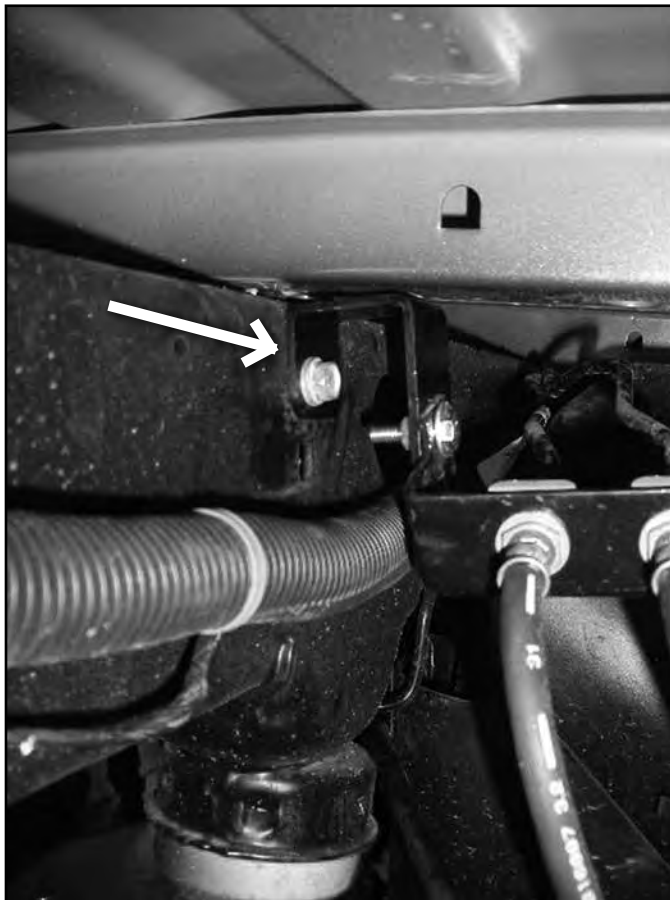
14. Attach axle to springs with new u-bolts. Run the u-bolts from bottom up and through the new u-bolt plate. Snug the hardware at this time, but do not torque to specification.
15. Repeat block installation for driver's side.
16. Carefully form the brake bracket at the axle to point up at approximately 45 degrees. Bend the e-brake cable bracket at the top of the differential to give enough slack at full droop. (Fig R8)

FIGURE R8



17. 3" & 5" Rear block kit only: Attach brake line relocation bracket (SBCA) to the frame rail with factory hardware. Use the hole that will allow the bracket to be offset slightly forward.
18. Attach the brake line to the relocation bracket with ¼" x 1-1/4" hardware (BP 588). Tighten to 20 ft-lbs. Form the brake lines to clear the fuel tank if necessary. (Fig R9)

FIGURE R9



19. Remove the e-brake cable from the factory hanger in front of the leaf spring. Place the relocation bracket (SBCE) so the cable will go through the slot and the bottom formed edge lines up with the frame bracket.
20. Clearance the hole from the original e-brake location to clear the e-brake extension tube (if necessary). Insert the e-brake cable through the extension tube. (Fig R10a)

FIGURE R10A



FIGURE R10B



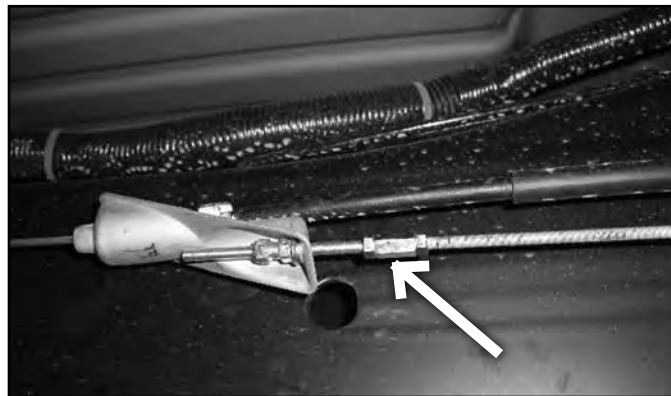
21. Thread on a M6 jam nut and the coupler nut to the e-brake cable (BP 588). Adjust the coupler nut depth to have half of the threads engaged. (Fig R11)

FIGURE R11



22. Attach the M6 threaded extension (SBTE) with jam nut and tighten securely.
23. Reattach the e-brake cable to the junction block with the factory adjuster nut. Tighten until the e-brake cable is at the appropriate tension. Test the e-brake to make sure it functions properly. Adjust tension if necessary. (Fig R12) Check the e-brake cable clearance where it passes through the original hole it was removed from in step 18. If necessary, drill this hole out to 5/8" to provide more clearance and prevent the cable from catching the hole edge. (Fig R10)

FIGURE R12

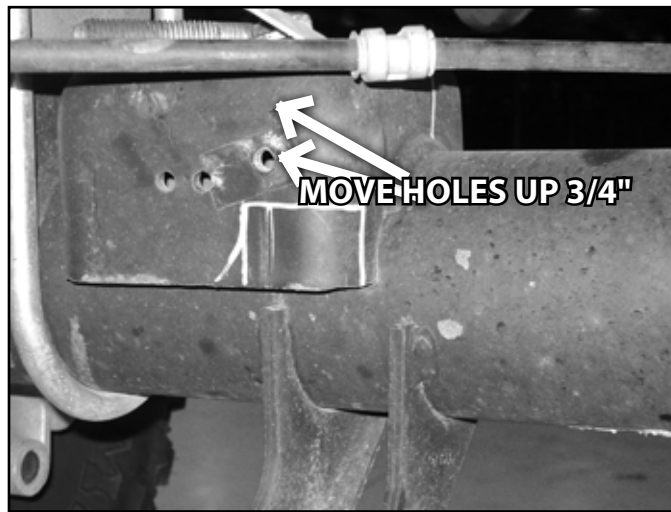


24. Reinstall the E-brake cable bracket near the jounce bumper with factory hardware.
25. Check all cables for adequate slack at full droop, make adjustments if necessary.
26. Install new rear shocks tighten hardware to 650 ft-lbs. 3" & 5" rear box kit



Tip *SHOCK NOTE: If installing BDS (white / silver) or Fox 2.5" diameter shocks, the passenger's side axle bump stop pad will need to be trimmed for proper clearance of the larger-than-factory shock body as well as relocation of the e-brake cable bracket. Fox 2.5" shocks will require trimming on the driver's side as well. Measuring from the bottom inside corner of the pad (near the shock mount), make cut marks 1" up from the bottom and 1-1/4" outward from the inside edge. Also measure back from the front face 3/8" (Fig R14) Cut the square section out with a cut-off tool. Paint exposed metal. The e-brake bracket will need to be relocated up 3/4". Transfer the holes up 3/4" and drill to 7/32". Reattach the bracket with new 1/4" x 1" self threading bolt (bolt pack # 588).*

FIGURE R14



27. Remove clips on wheels (Fig R15). Reinstall wheels and lower vehicle to the ground. Torque u-bolts to 125 ft-lbs. Torque lug nuts to 140 ft-lbs.

FIGURE R15



POST-INSTALLATION

1. Check all hardware for proper torque.
2. Reconnect the positive and negative battery cables.

FINAL CHECK

3. The vehicle will need a complete front end alignment. Variations in ride height will affect alignment. Do not adjust coilovers down to a lower height, or alignment may not be possible. If alignment specifications are difficult to achieve, additional positive caster is acceptable and recommended for improved driving characteristics.
4. Check all hardware after 500 miles.
5. Adjust headlights.



WE WANT TO SEE YOUR RIDE!

Grab photos of your BDS-equipped truck in action and send them in for a chance to be featured. Send it in to our Bad Ass Rides customer gallery at bds-suspension.com/bar and post them on the BDS Fan Page on Facebook at facebook.com/BDSSuspensions. Don't forget about your BDS swag! BDS offers t-shirts, hoodies, decals and more available on the BDS website or through your local BDS distributor.

TIME TO HAVE SOME FUN

Thank you for choosing BDS Suspension.

For questions, technical support and warranty issues relating to this BDS Suspension product, please contact your distributor/installer before contacting BDS Suspension directly.