

# INSTALLATION GUIDE



Part#: 021672

**HARDCORE LIMITED LIFETIME WARRANTY**

## 5.5" Suspension System

**Chevy Colorado / GMC Canyon 4WD | 2015-16**

Rev. 082217

491 W. Garfield Ave., Coldwater, MI 49036 • Phone: 517-279-2135

E-mail: [tech-bds@sporttruckusainc.com](mailto:tech-bds@sporttruckusainc.com)



# Read And Understand All Instructions And Warnings Prior To Installation Of System And Operation Of Vehicle.

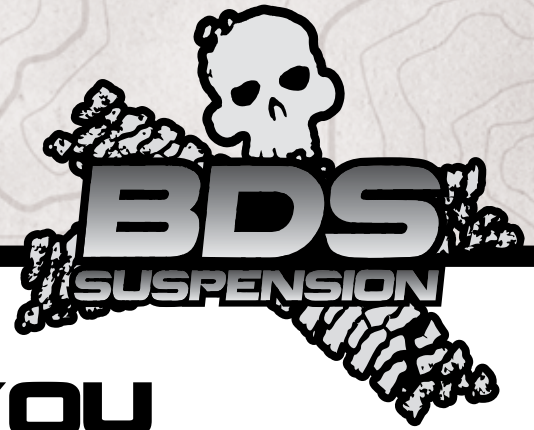

## THANK YOU

Your truck is about to be fitted with the best suspension system on the market today. That means you will be driving the baddest looking truck in the neighborhood, and you'll have the warranty to ensure that it stays that way for years to come.

Thank you for choosing BDS Suspension!

### BEFORE YOU START

BDS Suspension Co. recommends this system be installed by a professional technician. In addition to these instructions, professional knowledge of disassembly/ reassembly procedures and post installation checks must be known.

### FOR YOUR SAFETY

Certain BDS Suspension products are intended to improve off-road performance. Modifying your vehicle for off-road use may result in the vehicle handling differently than a factory equipped vehicle. Extreme care must be used to prevent loss of control or vehicle rollover. Failure to drive your modified vehicle safely may result in serious injury or death. BDS Suspension Co. does not recommend the combined use of suspension lifts, body lifts, or other lifting devices. You should never operate your modified vehicle under the influence of alcohol or drugs. Always drive your modified vehicle at reduced speeds to ensure your ability to control your vehicle under all driving conditions. Always wear your seat belt.

### BEFORE INSTALLATION

- Special literature required: OE Service Manual for model/year of vehicle. Refer to manual for proper disassembly/reassembly procedures of OE and related components.
- Adhere to recommendations when replacement fasteners, retainers and keepers are called out in the OE manual.
- Larger rim and tire combinations may increase leverage on suspension, steering, and related components. When selecting combinations larger than OE, consider the additional stress you could be inducing on the OE and related components.
- Post suspension system vehicles may experience drive line vibrations. Angles may require tuning, slider on shaft may require replacement, shafts may need to be lengthened or trued, and U-joints may need to be replaced.
- Secure and properly block vehicle prior to installation of BDS Suspension components. Always wear safety glasses when using power tools.
- If installation is to be performed without a hoist, BDS Suspension Co. recommends rear alterations first.
- Due to payload options and initial ride height variances, the amount of lift is a base figure. Final ride height dimensions may vary in accordance to original vehicle attitude. Always measure the attitude prior to beginning installation.



Visit [560plus.com](http://560plus.com) for more information.

### TIRES AND WHEELS

305/55/20 Tire  
Max 5-1/4" Backspace Wheel



### BEFORE YOU DRIVE

Check all fasteners for proper torque. Check to ensure for adequate clearance between all rotating, mobile, fixed, and heated members. Verify clearance between exhaust and brake lines, fuel lines, fuel tank, floor boards and wiring harness. Check steering gear for clearance. Test and inspect brake system.

Perform steering sweep to ensure front brake hoses have adequate slack and do not contact any rotating, mobile or heated members. Inspect rear brake hoses at full extension for adequate slack. Failure to perform hose check/ replacement may result in component failure. Longer replacement hoses, if needed can be purchased from a local parts supplier.

Perform head light check and adjustment.

Re-torque all fasteners after 500 miles. Always inspect fasteners and components during routine servicing.

# CONTENTS OF YOUR KIT

021670 / 021671DRV Knuckle Box Kit		
Part #	Qty	Description
02800	1	Steering Knuckle - DRV (021670) or
02801	1	Steering Knuckle - Pass (021671)
401-1830	1	Tie Rod End (021670-021671)
W96S	1	9/16" SAE washer (021670-021671)

Box Kit 021672		
Part #	Qty	Description
02807	1	Colorado - Front x-member - BDS
02808	1	Colorado - Rear x-member - BDS
02816	1	BDS Backing Plate - Aluminum
02809	1	Colorado - DRV Diff Drop - BDS
02810		Colorado - Pass Diff Drop - BDS
B1128		Bag Kit - Bolt Packs
680	1	Bolt Pack (Colorado Cross Member)
	4	5/8"-11 x 4-1/2 bolt - grade 8
	8	5/8" SAE Thru-Hardened Washer
	4	5/8"-11 Prevailing Torque Nut
681	1	Bolt Pack (Diff Drop Hardware)
	3	9/16"-12 x 3-1/2" Bolt - Grade 8
	6	9/16" SAE Thru-Hardened Washer
	3	9/16"-12 Prevailing Torque Nut
	2	14mm-2.00 x 35mm Bolt
	2	9/16" SAE Washer - clear zinc

021674 Strut Spacer Box Kit		
Part #	Qty	Description
02812	2	Colorado - 5.5" Strut Spacer - BDS
943	1	Bolt Pack - Strut Spacers
	6	3/8"-16 Nylock Nut
	6	3/8" SAE Washer

011406 4" Rear Box Kit		
Part #	Qty	Description
02815	2	4" Rear Block
962961138QB	4	9/16" x 2-9/16" x 11-3/8" U-Bolt - Black
B1131	1	Bag Kit
099000	5	Zip Ties
W96S-B	8	9/16" SAE Washer - black
N96FH-B	8	9/16" High Nut - black

Box Kit 021673		
Part #	Qty	Description
02811	1	Colorado - Diff Skid Plate - BDS
911122	2	Sway Bar Link - Colorado
02813	1	Colorado Bump Stop - BDS - drv
02814	1	Colorado Bump Stop - BDS - pass
B1129	1	Bag Kit Sway Bar / Bump Stops
4805G8	8	Sway Bar Link Bushing
682	1	Bolt Pack (Sway Bar Links)
	8	7/16" USS Flat Washer - Grade 9 - yellow zinc
	4	7/16"-14 Nylock Nut - yellow zinc
683	1	Bolt Pack (Skid Plate / Bump Stop / Misc.)
	8	1/2"-13 x 1-1/4" Bolt - Grade 8
	2	1/2"-13 x 2" Bolt - Grade 8
	12	1/2" SAE Thru-Hardened Washer
	2	1/2"-13 Prevailing Torque Nut
	2	7/16" 0.281 Hole Vinyl Cushion Wire Clip
	4	3/16" Cable Clamp
	4	1/4"-20 x 3/4" Self Threading Bolt
	2	10-24 x 3/4" Button Head Bolt - Stainless
	2	#10 SAE Washer
	2	10-24 Nylock Nut
95105A159	3	1/2" Rivet Nut
799	1	Bolt Pack (Rivet Nut Installation)
	1	1/2"-13 x 2" Bolt - Grade 8
	1	1/2" SAE Washer
	1	1/2" Star Washer
	1	9/16"-18 High Hex Nut
099000	4	Zip Tie
A294	1	Index Ring Assembly w/ (5) Studs
03520	1	2015-2016 / 2017+Colorado Index Ring
ARP15AJ1	5	3/8"-24 Press in stud
B1130	1	Bag Kit - Index Ring
827	1	Bolt Pack - Index Ring Kit
	7	10mm-1.50 x 30mm FHSCS - Class 10.9
	7	3/8"-24 Hex Nut - Gr 8
	7	3/8" - NAS Washer
ARP15AJ1	2	3/8"-24 Press-in Stud
02824	1	Colorado Front Drive Shaft Spacer
W96USS	3	9/16" USS Washers
828	1	Bolt Pack - Drive Shaft Spacer
	6	10mm-1.50 x 75mm Allen Bolt - Class 12.9
loc-tite	1	Loctite

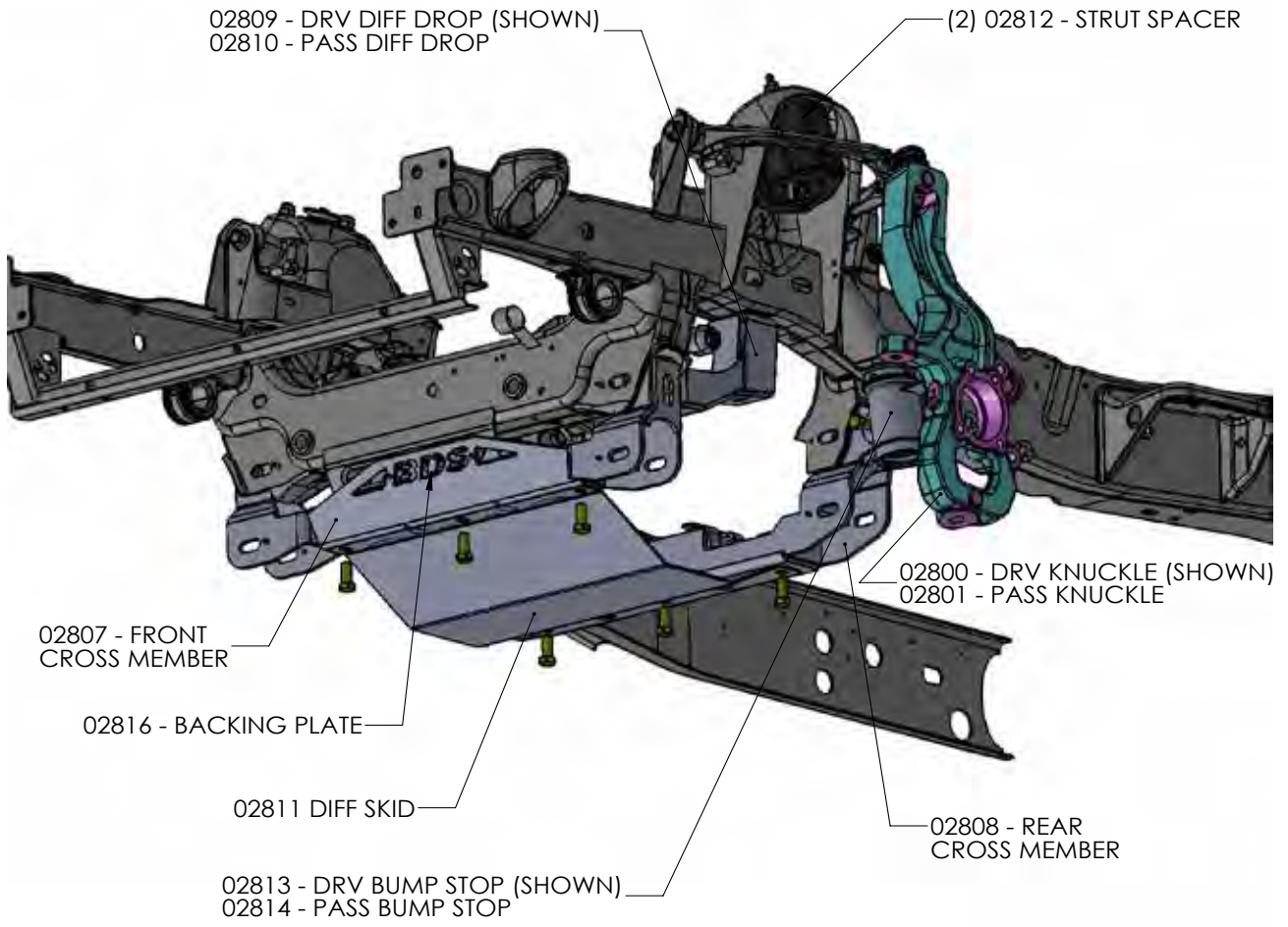

BOX KIT  
PART NUMBER  
DESCRIPTION

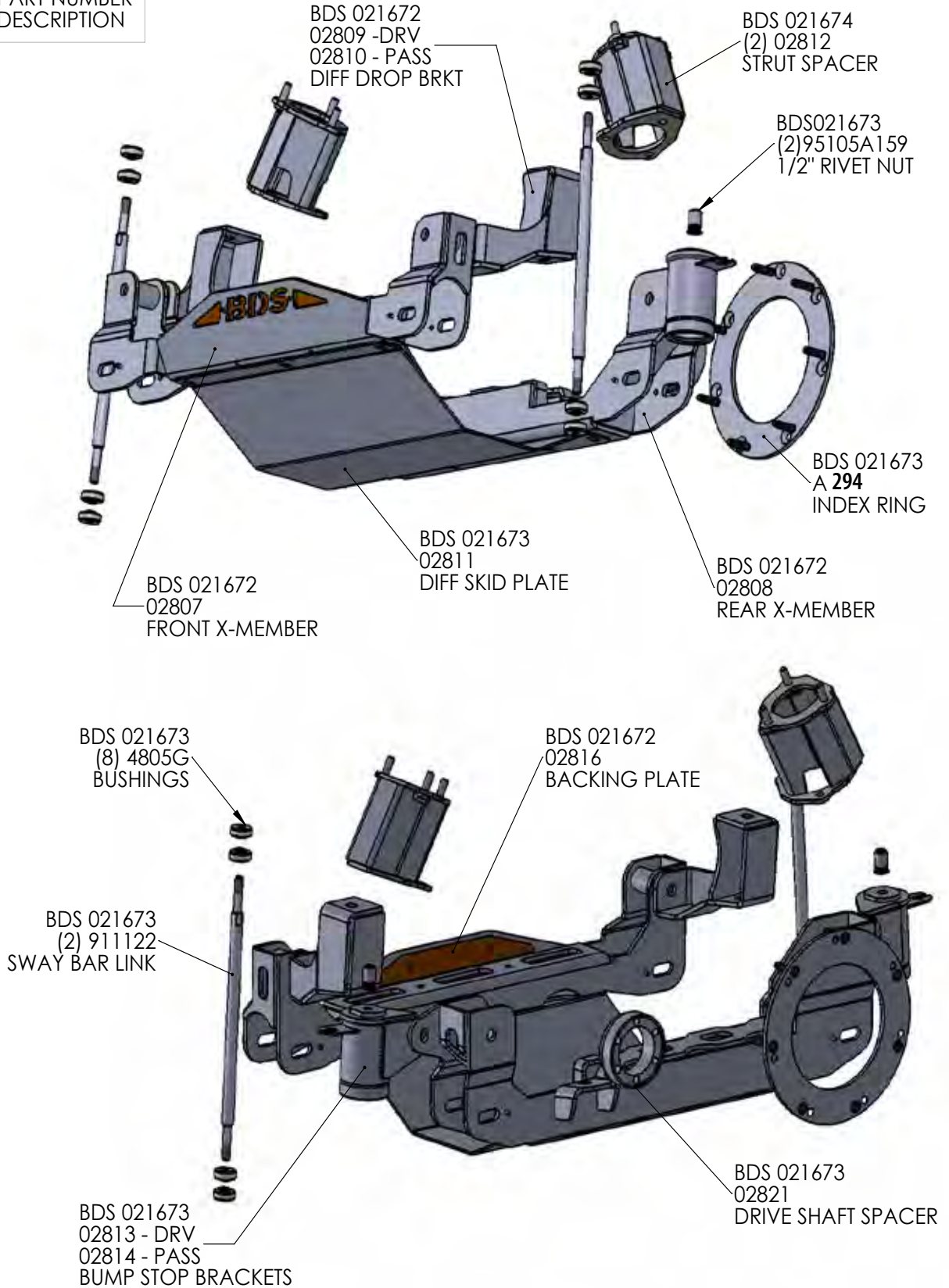



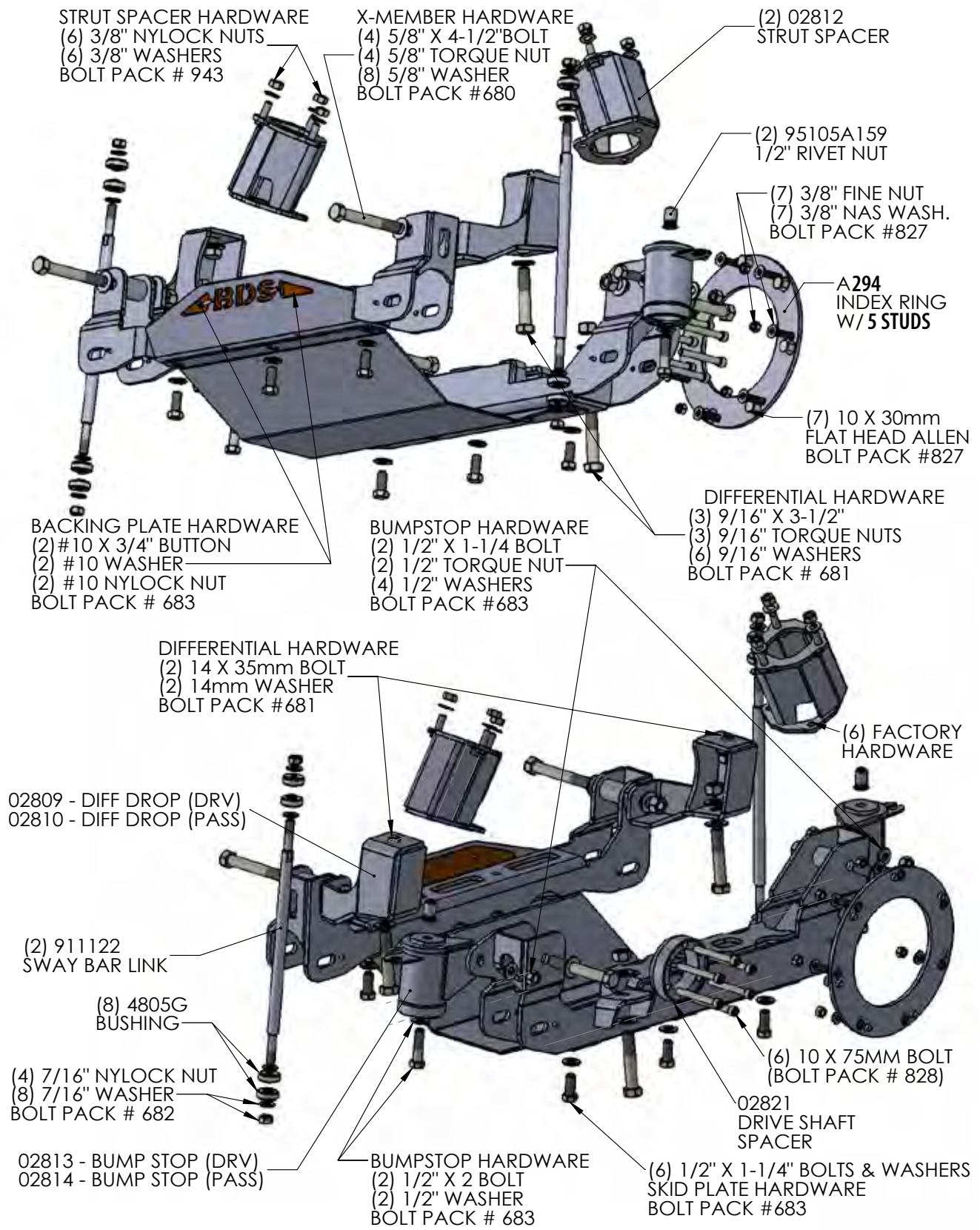

## TROUBLESHOOTING INFORMATION FOR YOUR VEHICLE

1. If using a plasma cutter for frame bracket modification, disconnecting the battery is highly recommended.
2. Stock 17" & 18" wheels can not be reinstalled with the lift kit. Aftermarket 20" wheels with maximum of 5.25" Backspacing are recommended - certain wheel and tire combinations will require weld on steering stops, these are included in the kit. See end of inst. sheet for details on installation.
3. 6 cylinder models require slight exhaust modification. 4 cylinder / Diesel models could possibly require exhaust modification
4. Rack and Pinion steering is sensitive to tire choice. Tires with large lugs, little backspacing, or extreme amounts of weight may induce a steering wheel bobble.
5. Index ring is dual drilled to work for 2015-2016 / 2017+ model years. There are (5) studs that are similar between all year model trucks. Match up the remaining two studs to transfer case and install studs by pressing into the bracket

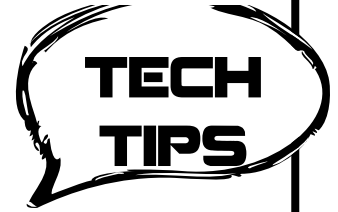

# INSTALLATION INSTRUCTIONS

## INSTALLATION INSTRUCTIONS

1. Park vehicle on clean, flat, and level surface. Block the rear wheels for safety, chock both the front and backside of the tires. Put the transmission in Neutral (required for index ring installation)
2. Disconnect the battery.
3. Raise the front of the vehicle and support the frame rails with jackstands.
4. If a plasma cutter is to be used for frame bracket modification (later in installation), it is recommended to disconnect the battery at this time.
5. Remove the front wheels

## SPECIAL TOOLS

36mm Socket, Air Hammer / Chisel highly recommended  
Plasma Cutter or other cutting device (sawzall or cutoff wheel)

## DISASSEMBLY INSTRUCTIONS

6. Remove any differential skid plates (if equipped) and the front splash shield from the vehicle. None of the factory skid plates will be reinstalled.
7. Remove the clip from the brake line to allow the brake line to detach from the bolt on brake line bracket.
8. Remove the brake bracket from the side of the upper strut mount, discard flanged bolt. (Fig 1). Remove the bracket from the vehicle by cutting a slot in the bracket for clearance to the brake line. Discard bracket, it will not be reused.

**FIG 1**

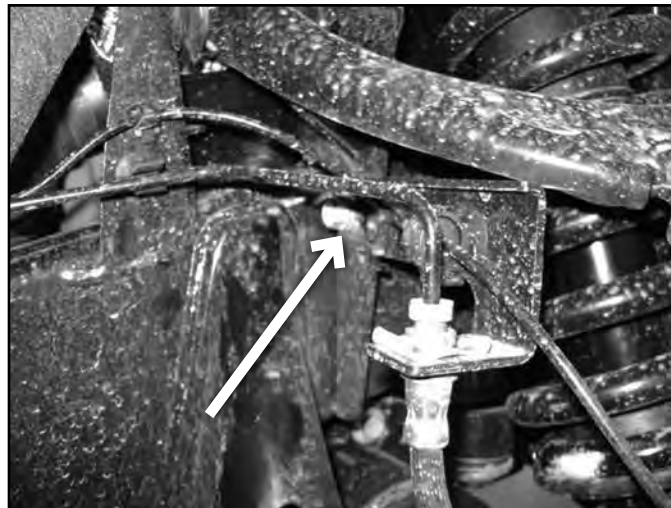

9. Disconnect the brake caliper from the steering knuckle, retain mounting bolts. Hang the caliper out of the way; do NOT allow the caliper to hang from the brake line. (Fig 2)

**FIG 2**

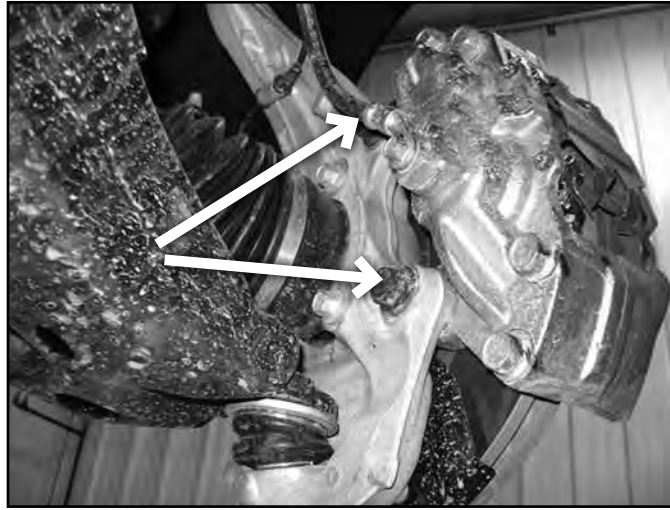

10. Remove the torx head bolt (T30) that attaches the rotor to the hub. Keep bolt for reinstallation. (Fig 3)

**FIG 3**



11. Disconnect the ABS wire from the backside of the steering knuckle, remove the clip and retain the bolt. (Fig 4)

**FIG 4**

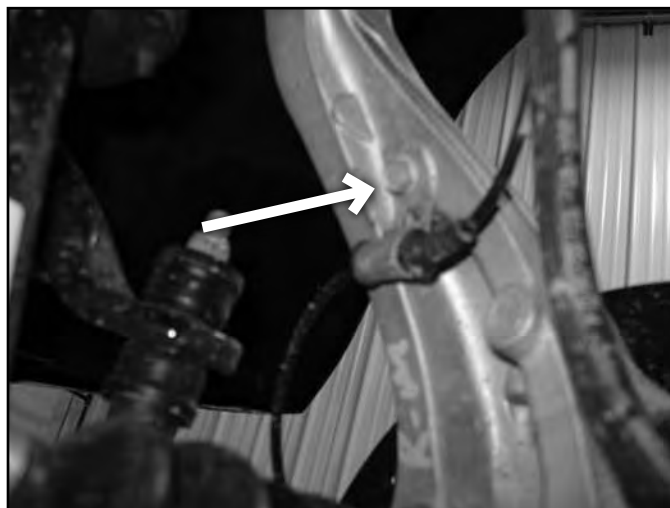



12. Remove the ABS sensor from the side of the knuckle (T30), retain mounting bolt. (Fig 5)

**FIG 5**



13. Remove the CV nut. CV's have a tight fit to the hubs, it may be necessary to use an air hammer to separate them. Reinstall the nut a few turns to keep from damaging the CV shaft if this method is used. (Fig 6)

**FIG 6**



14. Remove the factory sway bar links, they will not be reused.
15. Break the jam nuts loose on the tie rod ends at this time. The factory tie rod ends will be replaced later in the installation.
16. Remove the ball joint nuts and tie rod end nuts. Use an appropriate tool to unseat the tapers from the factory knuckle. It is NOT recommended to use a hammer to separate the joints if the knuckles are ever planned to be reused. (Fig 7, 8)

**FIG 7**

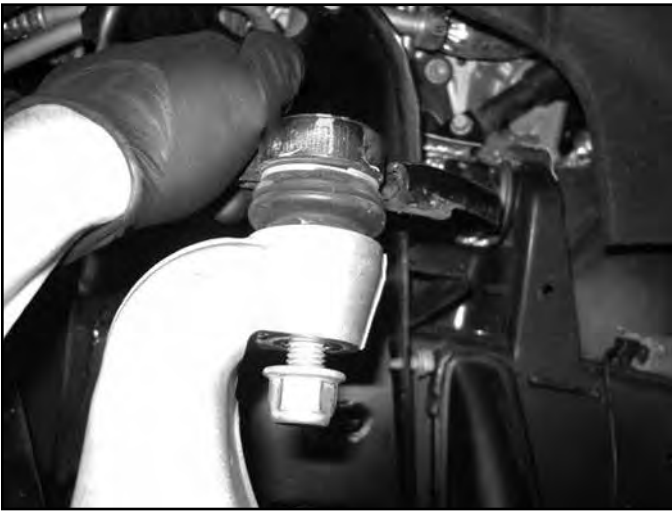

**FIG 8**



17. Remove the knuckle and hub assembly from the vehicle.
18. Remove the lower control arms. Retain the cam bolts / washers. (Fig 9, 10)

**FIG 9**



**FIG 10**



19. Remove the factory struts. Remove the lower bolt that attaches to the control arm and the 3 nuts that attach the strut to the upper strut mount. Do NOT remove the center nut that holds the strut assembly together.

### **DIFFERENTIAL REMOVAL**

20. Disconnect the differential breather hose from the differential and the central axle disconnect wiring harness (Fig 11, 12)



**Tip** *The differential breather line is tough to access, wait until the differential is lowered a slight amount to pull the hose off if necessary.*

**FIG 11**



**FIG 12**



21. Disconnect the front drive shaft from the differential. Discard front mounting hardware, it will not be reused) (Fig 13). Disconnect the front driveshaft from the transfer case, *SAVE* hardware, it will be reused. Remove the front driveshaft from the vehicle.

**FIG 13**



22. Remove the rear differential mounting bolt (Fig 14). Remove the rear factory cross member (Fig 15), Discard hardware, it will not be reused.

**FIG 14**



**FIG 15**

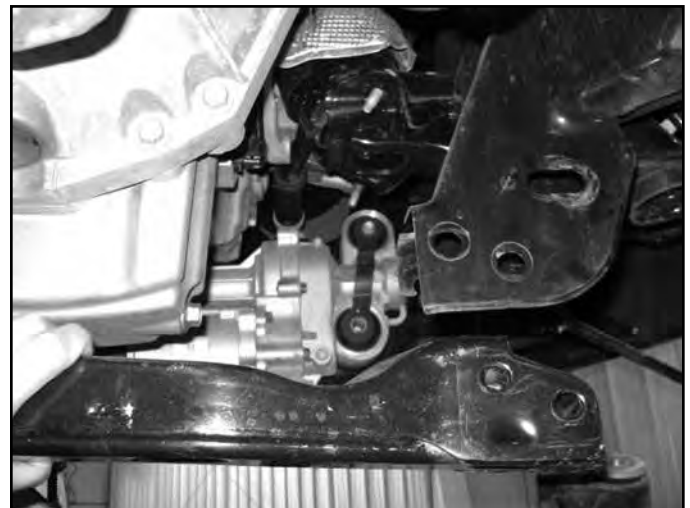



23. Support the differential with a hydraulic jack (transmission jack preferred). Remove the remaining two front mounting bolts and lower the differential from the vehicle. (Fig 16)

**FIG 16**



### **FRAME MODIFICATION**

24. The front factory lower control arm pocket will need to be modified to allow the new crossmember to be installed.

### **FRONT POCKET MODIFICATION**

25. Measure down 1-1/8" from the BOTTOM of the factory slot on both the front and back sides and make a horizontal mark. Connect these two lines by measuring 'in' towards the center of the vehicle 1-1/8" and making a line that goes from front to back. Remove this section of material from the vehicle. Use a grinder to make the faces flush and remove any sharp edges so that the cross member can be installed easily. Coat with paint. (Fig 17a, 17b, 17c, & 17d)



**Tip** Due to the factory forming of the front pocket, it can be difficult to install the front crossmember. Use a hammer or adjustable wrench to unflair the factory pocket if necessary.

**FIG 17A**



**FIG17B**



**FIG 17C**



**FIG 17D**

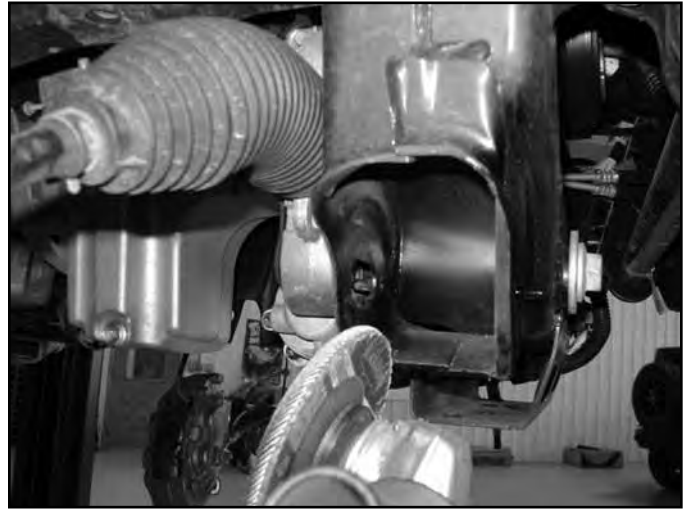

**PASSENGER'S REAR POCKET MODIFICATION**

26. Draw a line that connects the top of the outside slot and bottom of the inside slot and remove the material from vehicle. Use a grinder to remove sharp edges, coat with paint when completed. (Fig 18a, 18b)

**FIG 18A**



**FIG 18B**



## DRIVER'S REAR POCKET MODIFICATION

27. Draw a horizontal line from the top of the outside slot.
28. Draw a vertical line from the center of the outside slot
29. Draw a line that would go through the center of the stock alignment pin that is perpendicular (about 45 degrees from horizontal) to the inside face.
30. Remove this section of material from the vehicle, remove any sharp edge with a grinder, and coat with paint. (Fig 19a, 19b, 19c, & 19d)

**FIG 19A**



**FIG 19B**



**FIG 19C**

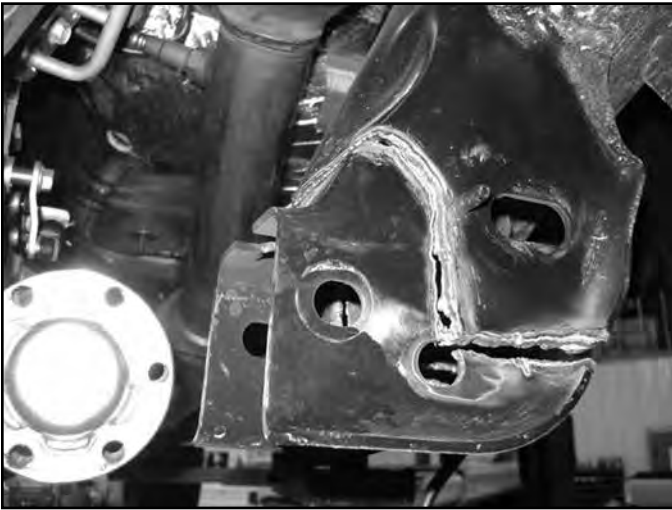

**FIG 19D**

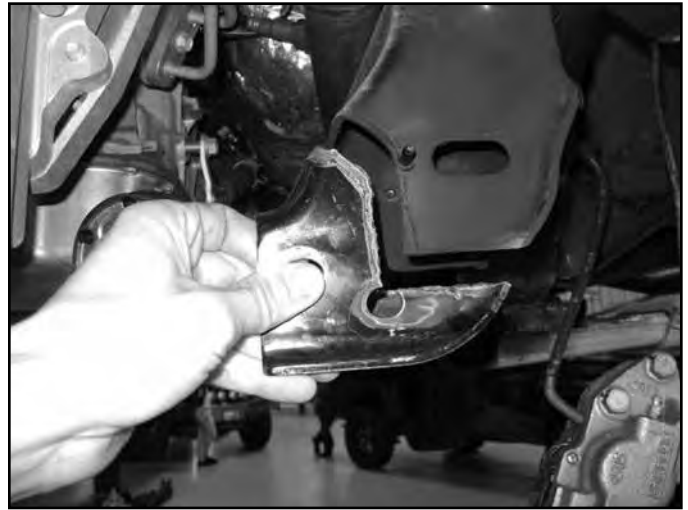

## CROSSMEMBER / DIFFERENTIAL INSTALLATION

31. Install the new front crossmember with new 5/8" x 4-1/2" hardware (BP #680). Run the bolts from front to rear, Do NOT put the nuts on the bolts at this time. Crossmember are a tight fit if not enough material was removed during the frame pocket modification. (Fig 20)



**FIG 20**



32. Install the new differential drop brackets (02809 – DRV, 02810 – PASS) with new 14mm x 30mm bolts and washers (BP #681) to the frame. Brackets will attach to the front cross member hardware, attach with 5/8" nuts and washers. Push the differential brackets all the way towards the front of the vehicle and tighten 14mm hardware to 95 ft-lbs. Leave 5/8" hardware loose. (Fig 21)

**FIG 21**



33. Install differential to the new drop brackets with 9/16" x 3-1/2" hardware (BP #681). (Fig 22a, 22b)

**FIG 22A**



**22B**



34. Raise the rear differential mount. Install rear cross member with new 5/8" x 4-1/2" hardware (BP #680). Attach differential to rear crossmember with new 9/16" x 3-1/2" hardware (BP#681). (Fig 23)

*Note: After test driving, if a vibration is present in the front driveshaft, use the provided 9/16" USS washers to space up the rear mount between the differential mount and the rear cross member. Gas model recommended to not use any spacer washers, Diesel model recommended to use two 9/16" spacer washers. Driving the vehicle and adding and removing spacer washers is the best way to reduce driveline vibrations.*

**FIG 23**



35. Reconnect the differential breather line and the central axle disconnect wiring harness.

## **BUMP STOP INSTALLATION**

36. Remove the factory bump stops, use a hammer and a punch to get the bump stops to pop out of the factory cup. (Fig 24)

**FIG 24**



37. Clearance the hole inside the bump stop cup to 11/16", a step drill is highly recommended, if one is not available, a rotary die grinder can be used. Insert and seat 1/2" rivet nut. Follow rivet nut installation at the end of the instruction sheet. (Fig 25)

 **Tip** See the end of the instruction sheet for how to install 1/2" rivet nuts. There is one extra rivet nut provided in the kit incase one is installed incorrectly. If both are installed correctly, there will be an extra rivet nut at the end of the installation.

**FIG 25**



38. Attach the new bump stop extension (02813 – DRV, 02814 – PASS) to the rivet nut with  $\frac{1}{2}$ " x 2" hardware (use socket and extension to attach) and to the cross member with  $\frac{1}{2}$ " x 1-1/4" bolt, washers, and nut. (BP #683) (Fig 26)

**FIG 26**

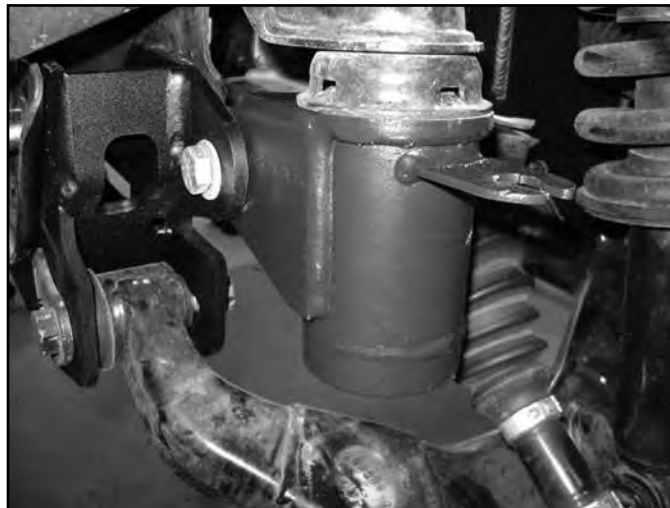

39. Install lower control arms with factory cam bolts and nuts. It is recommended to run the front bolts from Rear to Front, and the rear bolts from Front to Rear so that the nuts are easily accessible. They must be torqued to 170 ft-lbs later in the installation. Snug, but do not tighten at this time.
40. Go back and tighten 5/8" Differential / Crossmember hardware to 120 ft-lbs., 9/16" differential hardware to 90 ft-lbs., Tighten  $\frac{1}{2}$ " bump stop hardware to 65 ft-lbs.
41. Install the factory bump stops into the replacement bump stop brackets. Lube the bump stop with a small amount of grease, use a jack on the lower control arm to press the bump stops into the cup. (Fig 27)



**FIG 27**



**STRUT MODIFICATION OR OPTIONAL COILOVER INSTALLATION**

42. Locate the upper strut spacers (02812). Attach the strut spacers to the stock struts with factory hardware. Tighten to 40 ft-lbs. (Fig 28a, 28b) Note: Use a 3/8" chrome 18mm socket with a 3/8" swivel to tighten the nut inside the strut spacer.

**FIG 28A**



**FIG 28B**



43. Install the strut and spacer into the vehicle. Attach the strut to the upper mount with new 3/8" nylock nuts and washers (BP #943). Attach lower mount to the lower control arm with factory bolts. Tighten the 3/8" hardware to 35 ft-lbs, do NOT tighten the lower mount at this time. It will be done at the end of the installation with the vehicle weight on the ground. (Fig 29a, 29b)

**FIG 29A**



**FIG 29B**

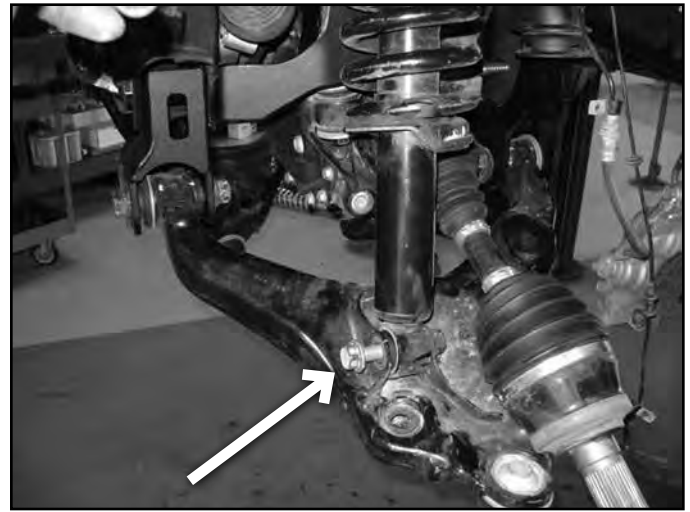

44. Optional: Install coilover assembly so that the hose is to the rear of the vehicle and loops below the upper control arm. Attach reservoir bracket and upper mount with included hardware. Use factory lower hardware to attach the bottom. Tighten upper hardware to 40 ft-lbs, lower hardware to 95 ft-lbs. Attach reservoir to the bracket with included hose clamps. Cycle the upper control arm to ensure there will be clearance between the hose at full droop and clearance to the reservoir under compression.

### **KNUCKLE ASSEMBLY**

45. Remove the factory hub and dust shield from the stock knuckles. Transfer them over to the new steering knuckle. Note: You MUST install the dust shield, failure to do so will cause ABS problems. (Fig 30)

**FIG 30**



46. Apply loctite to the factory hub bolts, and tighten hub hardware to 95 ft-lbs.
47. Install grease zerk into new tie rod ends. Install the new tie rod ends onto the factory inner tie rods.

48. Install new steering knuckle assembly to the lower control arm and run the CV shaft through the hub. Attach upper ball joint and new tie rod end to knuckle assembly, use the included washer under the nut for the tie rod end. Use stock hardware Tighten lower ball joint to 92 ft-lbs, upper ball joint to 70 ft-lbs, tie rod end to 44 ft-lbs, and CV nut to 177 ft-lbs.
49. Reinstall the brake rotors with the torx bit holding the rotor to the hub assembly.
50. Reinstall the brake calipers with factory hardware. Tighten to 148 ft-lbs.
51. Clean any debris from the ABS sensors. Install the ABS sensors into the steering knuckle with factory hardware. Tighten to 11 ft-lbs. (Fig 31a)
52. Attach the ABS sensor wire to the back of the steering knuckle with a new cable clamp (BP #683) and factory hardware. The grommet on the ABS wire can be slid by spraying it with silicone spray. Ensure there is adequate slack through wheel travel and full steering range of motion, ensure the ABS wire can not rub on the CV shaft. (Fig 31b)

**FIG 31A**



**FIG 31B**



53. Install new sway bar links (911122) with (8) washers and (8) bushings (4805G) as shown. Attach with (4) 7/16" nylock nuts (BP #682). (Fig 32) Tighten until the bushings begin to swell, do NOT over tighten the hardware.

**FIG 32**





## BRAKE LINE / ABS WIRE MODIFICATION

54. Carefully form the brake line to allow the mounting end to attach to the side of the bump stop cup. Reinstall the factory retaining clip to hold the brake line in place.
55. Reform the hard line slightly to create clearance from any sharp edges. Attach brake line to the side of the frame rail and the factory bump stop bracket by drilling  $7/32$ " holes and using  $3/16$ " cable clamps with  $1/4$ " self threading bolts (BP #683). (Fig 33)

**FIG 33**

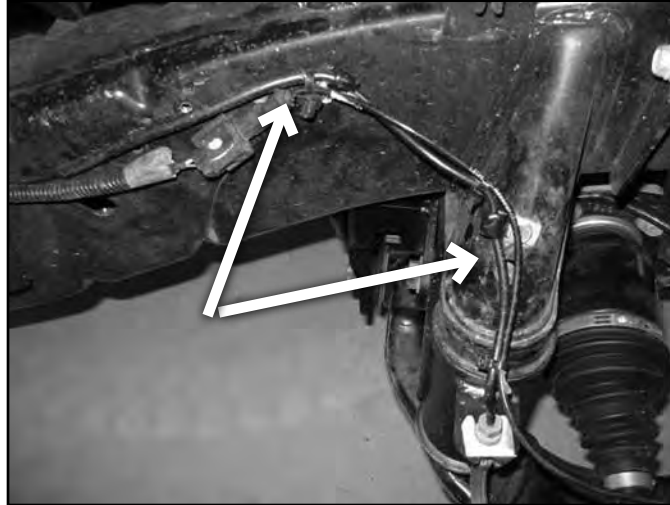

56. Zip tie the ABS wires to the brakeline to allow adequate slack through wheel travel and turning motions.

## INDEX RING INSTALLATION:

57. Note: The front driveshaft should be completely removed at this point, if it is not, remove and retain hardware, remove driveshaft from the vehicle.
58. Disconnect the U-joint hardware, remove straps, and disconnect rear drive shaft from the rear axle, remove rear driveshaft. (Fig 35).

**FIG 35**



59. Remove the differential skid plate if equipped (3 bolts), it will not be reinstated. (Fig 36)

**FIG 36**

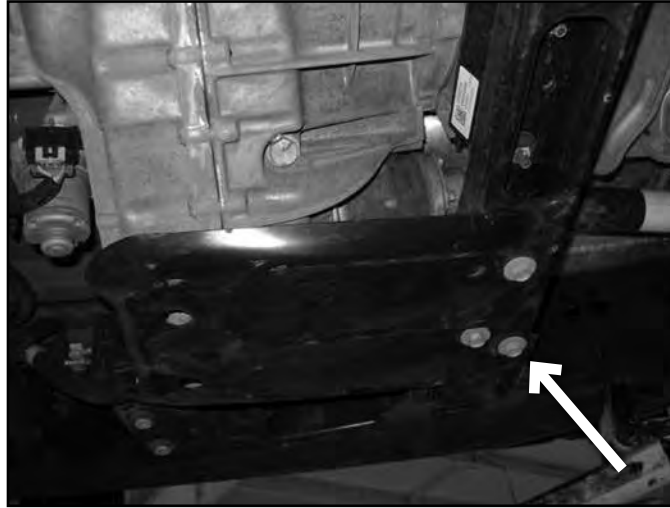

60. Disconnect the transfer case shift mechanism wiring harness, disconnect wiring harness clips from transfer case. (Fig 37a)

**FIG 37A**



61. Disconnect the breather from on top of the transfer case, above the front driveshaft output. (Fig 37b)

**FIG 37B**

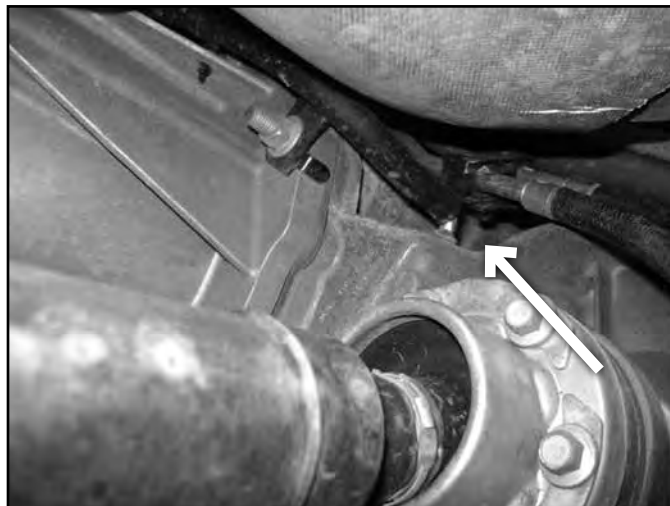

62. Support the transmission with a transmission jack, use extra care not to damage any surfaces on the transmission. Remove the factory transmission crossmember, remove the transmission mount, retain all hardware. (Fig 38a, 38b)

**FIG 38A**



**FIG 38B**



63. Support the transfer case. Remove the 7 nuts that hold the transfer case to the transmission and remove the transfer case from the vehicle.  
64. Remove the 7 studs from the transfer case. Double nut the factory nuts in order to remove them. (Fig 40)

**FIG 39**



65. Match up the missing (2) studs to the indexing ring based on the model year split for trucks (2015-2016 / 2017+). Press the studs into the indexing ring so the head is at the same height as the remaining studs.  
66. Install new index ring assembly with loctite on the new 10mm Flat Head Allen Bolts (BP #827), leave the factory gasket on the transfer case. Tighten to 35 ft-lbs (Fig 40a).



**Tip** *The indexing ring has a specific orientation, it will only go on one way, rotate until all of the holes align. Match the missing two studs up to the mating hole and install into the bracket.*

67. Reinstall transfer case with new indexing ring with new 3/8" washers and nuts, with loctite on the threads (BP #827). Tighten to 45 ft-lbs. (Fig 40b)



**FIG 40A****FIG 40B**

68. Reinstall transmission mount and crossmember with factory hardware, reattach wiring harness, and transfer case breather. Reinstall the rear driveshaft with factory straps and hardware. Tighten all hardware to factory specifications
69. The front crossover exhaust pipe will be close to the front driveshaft when installed. Loosely fit the front driveshaft and mark the area just below the driveshaft on the crossover pipe. Squish in the top part of the exhaust tube approximately 1/4" to create clearance when the driveshaft is installed. Use a clamp with support on the bottom side, or use a torch to heat the area and dent in with a hammer (Fig 41a).



**Tip** *When the front driveshaft is installed there will be approximately a 1/4" gap, this is not enough clearance when in 4wd and the crossover pipe must be modified.*

70. Reinstall the front driveshaft. Use factory hardware with loc-tite at the transfer case output. Attach driveshaft to the front differential with new 10mm bolts (BP #828) with loc-tite and driveshaft spacer (#02821). Torque to 45 ft-lbs. (Fig 41b)

**FIG 41A****FIG 41B**

### FINAL FRONT STEPS:

71. Recheck differential hardware for proper torque. Install skid plate (02811) with 1/2" x 1-1/4" bolts with washers (BP #683) Tighten to 65 ft-lbs.
72. Attach the backing plate to the backside of the front cross member with #10 stainless hardware (BP #683).
73. Recheck all front hardware for proper torque, cycle steering to check for adequate clearances.
74. Reinstall front wheels. Tighten to factory specifications.

75. Lower vehicle to the ground. Adjust Cams as shown (Fig 42a - front, Fig 42b - rear), Tighten Cam hardware to 170 ft-lbs. Tighten lower strut hardware to 95 ft-lbs.



**Tip** This is not the final alignment, but a good start for driving to an alignment shop. Adjust the toe-in to approximately 1/8" in, and straighten the steering wheel. Do NOT drive the vehicle with the steering wheel off-center.

**FIG 42A (FRONT)**



**FIG 42B (REAR)**



## REAR INSTALLATION

76. Block the front wheels for safety. Raise the rear of the vehicle and support frame rails with jackstands.
77. Remove the stock wheels and tires.
78. Disconnect the ABS wire from the clip on the side of the frame rail, this will allow extra slack in the ABS line. (Fig 43)

**FIG 43**



79. Remove the e-brake cable guide bracket from the side of the frame rail on the driver's side. It will not be reinstalled.
80. Form the stock brake line upper bracket 'down' to gain adequate slack. Use an adjustable wrench to form the stock brake line bracket down. (Fig 44a, 44b)

**FIG 44A**



**FIG 44B**



81. Working on one side of the vehicle at a time. Support the axle with a hydraulic jack, remove the factory u-bolts. Remove the stock shocks, retain hardware.
82. Diesel Models Only: To remove the driver side upper shock bolt the DEF tank may be needed to be slid over to provide clearance. If the bolt cannot be removed, follow these instructions to provide clearance to the DEF tank.

**FIG 45**



83. Lower the spare tire and remove the spare tire from the vehicle. Follow the factory manual for removal of the spare tire. Remove the heat shield protecting the spare tire from the exhaust. There are 3 plastic push pins supporting the heat shield.



**FIG 46**

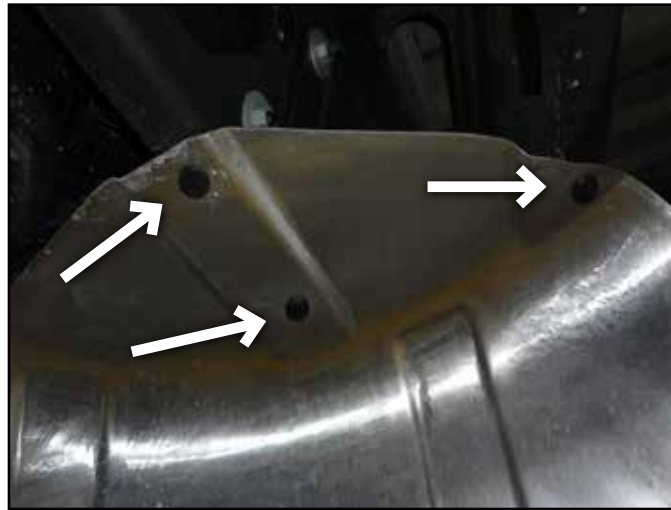

84. Support the DEF tank with a jack. Remove the two bolts supporting the front of the DEF tank. Remove the bolt on the passenger side of the DEF tank

**FIG 47**



**FIG 48**



85. Remove the two nuts on the back side of the DEF tank. The support brackets on the back side of the DEF may also need to be loosened in order to slide the DEF tank over.

**FIG 49**



**FIG 50**



86. Slide the DEF tank towards the passenger side of the vehicle until there is enough clearance to remove the driver side upper shock bolt. Install the new shock with the OEM shock bolt. After the new shock is installed, reinstall the DEF tank in the reverse sequence.
87. Lower the axle and install new lift block. Install new u-bolts with nuts and washers. Snug but do not tighten at this time. (Fig 45a, 45b)

**FIG 51A**



**FIG 51B**



88. Repeat block installation on opposite side of vehicle.
89. Grease and install new bushings and sleeves into shocks. Install the shocks with factory hardware. Tighten to 55 ft-lbs.
90. Lower the axle and check for adequate slack in the brake lines and abs wire, adjust as necessary.
91. Slide the grommet on the ABS wire on the passenger's side by the exhaust up (use silicone spray to allow the grommet to slide easily). Slide the ABS wire heat shield tubing up and secure with a zip tie. (Fig 52a)
92. Attach the ABS wire to the u-bolt with included zip tie (Fig 52b), repeat on opposite side.

**FIG 52A**



**FIG 52B**



93. Use two zip ties, secure the e-brake cables together in front of where the old e-brake cable guide bracket contacted the cables. (Fig 53)

**FIG 53**



94. Install wheels, tighten lug nuts to factory specifications.  
95. Lower the vehicle to the ground and torque u-bolts to 110 ft-lbs.  
96. Reconnect the battery.  
97. Recheck all hardware for proper torque. Check again after 500 miles.  
98. A front end alignment is now required. Ensure the lower cam bolts are torqued to 170 ft-lbs after alignment.

**OPTIONAL WELD ON STEERING STOPS:**

99. Included are optional weld on steering stops. These can be welded to the lower control arm to reduce rubbing or eliminate any interference issues that may be present at full steering lock. Disconnect the battery, prep lower control arm for welding, weld steering stop onto the lower control arm as shown. Coat with paint when completed. (Fig 54a, 54b)



**FIG 54A**



**FIG 54B**



**OPTIONAL FRONT FENDERWELL MODIFICATION FOR TIRE CLEARANCE:**

100. Remove the 4 lower T-15 Torx head bolts that hold the fenderwell to the plastic support piece. (Fig 55a, 55b)

**FIG 55A**



**FIG 55B**

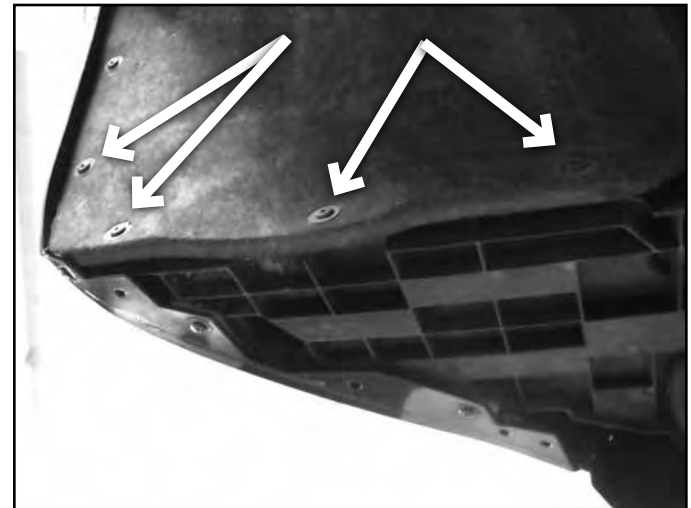

101. Trim back to the first full support rib. Remove this section from the support piece. (Fig 56a, 56b)

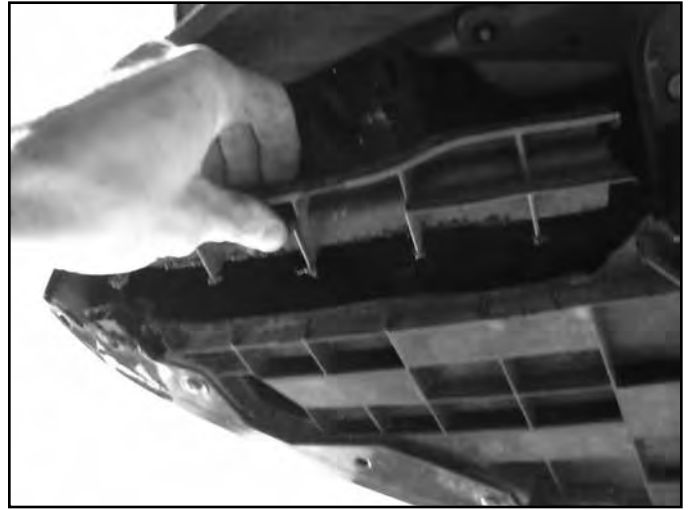

**Tip** A sawzall works well for trimming the factory plastic. A box cutter style knife with the blade heated by a MAP gas / propane torch cuts the factory plastic bumper cover nicely and leaves a good smooth finish.

**FIG 56A****FIG 56B**

102. Remove the nut clips from the trimmed piece. Hold the inner fenderwell up to the front support piece and drill new holes for the mounting hardware at a convenient location. Attach the inner fender to the plastic support piece with factory torx bit hardware. Trim a slight amount on the plastic bumper cover for additional clearance if required. (Fig 57a, 57b)

**FIG 57A****FIG 57B**

## RIVET NUT INSTALLATION INSTRUCTIONS

### RIVET NUT SIZING

1. Verify the correct size rivet nut for the application based on the thickness of material where the rivet nut is to be installed using the following chart.

Part Number	Thread Size	Body Length (in)	Material Thickness (in)		Drill Size (in)
			Min.	Max.	
95105A159	3/8-16	.690	.027	.150	17/32
95105A168	3/8-16	.805	.150	.312	17/32
95105A169	1/2-13	1.150	.063	.200	11/16
95105A170	1/2-13	1.300	.200	.350	11/16

## HOLE PREPARATION

2. Drill hole to appropriate size for rivet nut installation. 1/2" Rivnuts require an 11/16" hole and 3/8" Rivnuts require a 17/32" drill. It is critical that this hole is drilled to the correct size. Remove any burrs that could keep the rivet nut from seating flat against either side of the hole surface.



**Tip** *If the correct drill size is not available, it is possible to drill the hole to an available smaller size and slowly grind it out to until the rivet nut fits tight.*

## RIVET NUT INSTALLATION TOOL ASSEMBLY

3. For a 3/8" rivet nut, place the provided 3/8" SAE flat washer on the 3/8" x 1-1/2" bolt, followed by 7/16" hex nut and then a 3/8" serrated washer. (Fig. 1) Thread this tool assembly into the rivet nut.
4. For a 1/2" rivet nut, place the provided 1/2" SAE washer on a 1/2" x 2" bolt followed by a 9/16" high nut and 1/2" serrated edge lock washer. Thread this tool assembly into the rivet nut as shown. (Fig. 1)

**FIGURE 1- 1/2" RIVET NUT SHOWN**

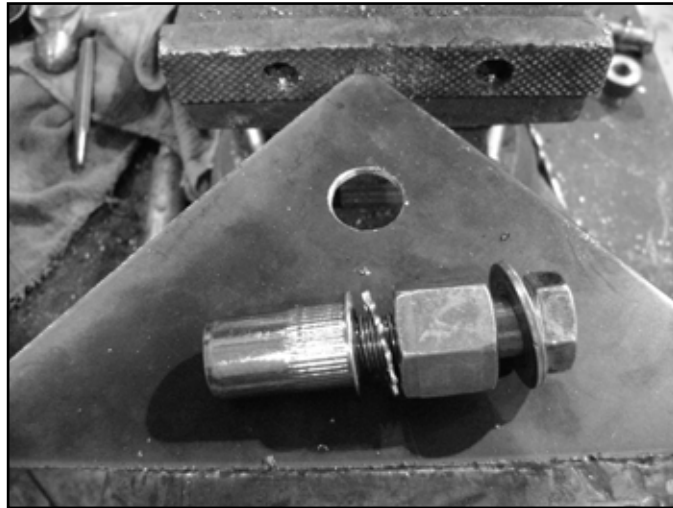

## RIVET NUT INSTALLATION

5. Place the installation tool with the rivet nut threaded on the end into the appropriately sized hole.
6. For a 3/8" rivet nut, hold the nut closest to the rivet nut still with a 5/8" wrench and tighten the 3/8" bolt with a 9/16" wrench to set the rivet nut. Be sure to hold the rivet nut flush to the surface and square to the hole as it is tightened. (Fig. 2)



**Tip** *If available, an impact gun is recommended for tightening the bolt to ensure the rivet nut remains square to the hole and to ease holding the nut from spinning.*

7. For a 1/2" rivet nut, hold the nut closest to the rivet nut still with a 7/8" wrench and tighten the 1/2" bolt with a 3/4" wrench to set the rivet nut. Be sure to hold the rivet nut flush to the surface and square to the hole as it is tightened. (Fig. 2)

**FIGURE 2 - 1/2" RIVET NUT SHOWN**





## TORQUE SPECIFICATIONS

- 3/8" rivet nuts will approach 40 ft. lbs for maximum grip strength. Do not exceed 45 ft-lbs when setting the rivet nut.
- 1/2" rivet nuts will approach 90 ft lbs for maximum grip strength. Do not exceed 100 ft-lbs when setting the rivet nut.



### Tip

*Note: If using the recommended impact gun, use caution to not exceed the recommended torque specifications.*

## RIVET NUT TOOL REMOVAL

- Once the center bolt is tightened, remain holding the nut from spinning with the wrench and loosen the center bolt to remove the installation tool.



### Caution

*It is very important to hold the nut as the bolt is loosened because the grip of the star washer will try to spin the rivet nut and ruin the installation.*

- Verify proper installation by checking for consistent rivet nut deformation to see the threads are square and centered to the rivet nut. (Fig. 3)

**FIGURE 3**

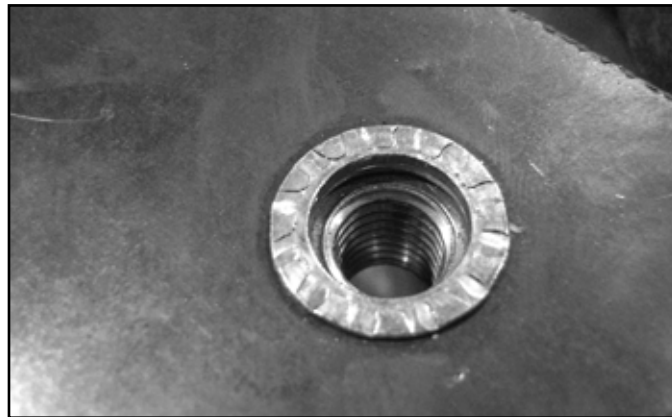

## **WE WANT TO SEE YOUR RIDE!**

Grab photos of your BDS-equipped truck in action and send them in for a chance to be featured. Send it in to our Bad Ass Rides customer gallery at [bds-suspension.com/bar](http://bds-suspension.com/bar) and post them on the BDS Fan Page on Facebook at [facebook.com/BDSSuspensions](https://facebook.com/BDSSuspensions). Don't forget about your BDS swag! BDS offers t-shirts, hoodies, decals and more available on the BDS website or through your local BDS distributor.

---

## **TIME TO HAVE SOME FUN**

**Thank you for choosing BDS Suspension.**

For questions, technical support and warranty issues relating to this BDS Suspension product, please contact your distributor/installer before contacting BDS Suspension directly.