



TUFF COUNTRY™

EZ - Ride Suspension

PART NUMBER : 13740
1988 — 1991 CHEVY SUBURBAN 3/4 TON
3" SUSPENSION SYSTEM / WITH REAR BLOCKS

PARTS LIST:

Part #	Description	Qty.
BL401	4" Rear Lifted Blocks	2
5U-6109R	5/8" X 3 1/2" X 9 5/8" Round U-bolts	1
5U-3507R	5/8" X 3" X 7 5/8" Round U-bolts	3
5U-6112R	5/8" X 3 1/2" X 12 1/2" Round U-bolts	4
58NW	5/8" High Nuts & Washers	2
GMSBNB2	Front Spring Eye Bolts	1
GMBLNB	Front & Rear Brake Line Extensions & Hardware	1
MO2360	Front Spring Eye Bushings	4
S10006	Front Spring Eye Sleeves	2
LUBE	Lube Pack	2
12740INST	Instruction Sheet	1

Special Note: This box kit includes the rear lifted blocks, front and rear U-bolts, front and rear brake line extensions and necessary hardware. Tuff Country EZ-Ride Suspension offers two styles of front springs, a Heavy Duty spring and a EZ-Ride spring. If you have not already ordered your front springs, please contact Tuff Country or your local Tuff Country dealer and order (2) 18370 (EZ-Ride Springs) or (2) 18371 (Heavy Duty Springs)

Congratulations on your selection to purchase a Tuff Country EZ-Ride Suspension System. We at Tuff Country are proud to offer a high quality product at the industries most competitive pricing. Thank you for your confidence in us, and our product.

Before installation begins, it is the customers/installers responsibility to make sure that all parts are on hand. If any parts are missing, please feel free to call one of our customer service representative @ (800) 288-2190.

Make sure to use locktite on all new and stock hardware associated with this installation.

It is the responsibility of the installers to make sure that the rear view mirror hanger is hung from the rear view mirror. The rear view mirror hanger has instructions on proper post installation procedures.

Torque Settings

5/16"	15—18 ft lbs.	3/8"	28—32 ft lbs.
7/16"	30—35 ft lbs.	1/2"	65—85 ft lbs.
9/16"	85—120 ft lbs.	5/8"	95—130 ft lbs.
3/4"	100—140 ft lbs.		

INSTALLATION MANUAL

3" SUSPENSION SYSTEM

CHEVY/GMC SUBURBAN 3/4 TON

1988 — 1991
PART # 13740

SJ050702

Tuff Country EZ-Ride Suspension highly recommends that a qualified and or certified mechanic performs this installation.

If you desire to return your vehicle to stock, it is the customers responsibility to save all stock hardware.

IMPORTANT CUSTOMER INFORMATION

This vehicles reaction and handling characteristics may differ from standard cars and/or trucks. Modifications to improve and/or enhance off road performance may raise the intended center of gravity. Extreme caution must be utilized when encountering driving conditions which may cause vehicle imbalance or loss of control. **DRIVE SAFELY!** Avoid abrupt maneuvers, such as sudden sharp turns which could cause a roll over, resulting in serious injury or death.

It is the customers responsibility to make sure that a re-torque is performed on all hardware associated with this suspension system after the first 500 miles of installation. It is also the customers responsibility to do a complete re-torque after every 3000 miles or after every off road use.

After the original installation, Tuff Country EZ-Ride Suspension also recommends having the alignment check every 6 months to ensure proper tracking, proper wear on tires and front end components. Tuff Country EZ-Ride Suspension take no responsibility for abuse, improper installation or improper suspension maintenance.

It is the responsibility of the customer or the mechanic to wear safety glasses at all times when performing this installation.

It is the customers/installers responsibility to read and understand all steps before installation begins. OEM manual should be used as a reference guide.

The Tuff Country EZ-Ride Suspension product safety label that is included in your kit box must be installed inside the cab in plain view of all occupants.

It is the responsibility of the installers to make sure that the rear view mirror hanger is hung from the rear view mirror. The rear view mirror hanger has instructions on proper post installation procedure.

LIMITED LIFETIME WARRANTY

Notice to all Tuff Country EZ-Ride Suspension customers: It is your responsibility to keep your original sales receipt! If failure should occur on any Tuff Country EZ-Ride Suspension component, your original sales receipt must accompany the warranted unit to receive warranty. Warranty will be void if the customer can not provide the original sales receipt. Do not install a body lift in conjunction with a suspension system. If a body lift is used in conjunction with any Tuff Country EZ-Ride Suspension product, your Tuff Country EZ-Ride Suspension **WARRANTY WILL BE VOID.** Tuff Country Inc. ("Tuff Country") suspension products are warranted to be free from defects in material and workmanship for life if purchased, installed and maintained on a non-commercial vehicle; otherwise, for a period of twelve (12) months, from the date of purchase and installation on a commercial vehicle, or twelve thousand (12,000) miles (which ever occurs first). Tuff Country does not warrant or make any representations concerning Tuff Country Products when not installed and used strictly in accordance with the manufacturer's instructions for such installation and operation and accordance with good installation and maintenance practices of the automotive industry. This warranty does not apply to the cosmetic finish of Tuff Country products nor to Tuff Country products which have been altered, improperly installed, maintained, used or repaired, or damaged by accident, negligence, misuse or racing. ("Racing is used in its broadest sense, and, for example, without regards to formalities in relation to prizes, competition, etc.) This warranty is void if the product is removed from the original vehicle and re-installed on that or any other vehicle. This warranty is exclusive and is in lieu of any implied warranty of merchantability, fitness for a particular purpose or other warranty of quality, whether express or implied, except the warranty of title. All implied warranties are limited to the duration of this warranty. The remedies set forth in this warranty are exclusive. This warranty excludes all labor charges or other incidental or consequential damages. Any part or product returned for warranty claim must be returned through the dealer of the distributor from whom it was purchased. Tuff Country reserves the right to examine all parts returned to it for warranty claim to determine whether or not any such part has failed because of defect in material or workmanship. The obligation of Tuff Country under this warranty shall be limited to repairing, replacing or crediting, at its option, any part or product found to be so defective. Regardless of whether any part is repaired, replaced or credited under this warranty, shipping and/or transportation charges on the return of such product must be prepaid by the customer under this warranty.

Special Note: Tuff Country EZ-Ride Suspension recommends running a 32" x 12.50" tire for maximum tire clearance. Note: This tire size is not 100% accurate due to variations in wheel width, wheel off set, tire diameters and driving habits.

Please Follow Instruction Carefully

Before installation begins, drive and check to make sure there are no uncommon sounds and or frame damage. Also at this time measure from the center of the hub to the bottom of the fender well and record measurements below.

Pre Installation Measurements:

Driver Side Front: _____
Passenger Side Front: _____
Driver Side Rear: _____
Passenger Side Rear: _____

At the end of the installation take the same measurements and compare to the pre-installation measurements.

Post Installation Measurements:

Driver Side Front: _____
Passenger Side Front: _____
Driver Side Rear: _____
Passenger Side Rear: _____

Please follow instructions carefully:

Front End Installation:

1. To begin installation, block the rear tires of the vehicle so that the vehicle is stable and can't roll backwards. Safely lift the front of the vehicle and support the frame with jack stands. Place a jack stand on both the driver and passenger side. Next remove the wheels and tires from both sides.
2. Working on the driver side, remove the stock shock from the stock upper and lower mounting point and save hardware for later re-installation. The stock shock may be discarded. **Special Note: New longer front shocks are needed, if you have not already ordered shocks, please contact Tuff Country or your local Tuff Country dealer and order the proper shocks. Tuff Country recommends using a 23" fully extended nitrogen gas shock.** Repeat procedure on the passenger side. **Special Note: If the vehicle that you are working on has the dual shock option, remove both shocks and discard.**
3. Working on the driver side, disconnect the stock brake line at the frame mount. Let the stock brake line hang. **Special Note: Brake fluid is going to leak out, it is a good idea to place a bucket under the vehicle to**

catch the brake fluid that will leak out. After the installation is complete, the brake lines will need to be bleed. Repeat procedure on the passenger side.

See Illustration # 1

4. Place a pair of hydraulic floor jacks under the front axle. Place one hydraulic floor jack on the driver side and one on the passenger side.

5. Working on the driver side, remove the stock U-bolts from the stock location. The stock U-bolts and hardware may be discarded. Repeat procedure on the passenger side.

6. Carefully lower down on both hydraulic floor jacks at the same time approximately 3". This will allow enough room for the new front springs to be installed into the stock location.

7. Working on the driver side, remove the stock spring from the stock location. The stock front spring, stock front spring hanger hardware and stock front spring shackle hardware may be discarded. Repeat procedure on the passenger side.

8. Locate the new front leaf springs. Working on the front and rear eyelet's of the front springs, remove the new sleeves and bushings from each end and set the front eyelet bushings and sleeves a side for later re-installation. The rear eyelet bushings and sleeves may be discarded.

9. Locate the new polyurethane lube packs, (4) MO2360 spring eye bushings and (2) S10006 spring eye sleeves. Spread the new polyurethane over the new bushings and re-install them back into the new front spring assembly. Make sure to re-install the new sleeves.

Special Note: Make sure to use the new polyurethane lube packs prior to inserting the new bushings back into the new front springs. This will increase the life of the bushing, prevent squeaking and help with ride quality.

10. Locate the new front spring eye hardware. Working on the driver side, install the new front spring into the stock location and secure using the new spring eye hardware. **Make sure to use thread locker or locktite on these bolts.** Torque the front spring eye hanger hardware to 120 ft lbs. **Special Note: Do not torque the front spring eye shackle hardware at this time. Once the vehicle is lowered to the ground, the front spring eye shackle will be torque to 40 ft lbs.** Repeat procedure on the passenger side.

**See Illustration # 2 / Front Spring Hanger
See Illustration # 3 / Front Spring Shackle**

11. Carefully raise up on both hydraulic floor jacks at the same time until the newly installed front springs seat properly to the stock front spring perches.

12. Locate (2) new 5/8" x 3" x 7 5/8" Round U-bolts, (4) 5/8" U-bolt High Nuts and (4) 5/8" U-bolt Washers. Working on the driver side, install the new U-bolts into the stock location and secure using the new U-bolt high nuts and washers. Torque to **130 ft lbs.**

See Illustration # 4

13. Locate (1) new 5/8" x 3" x 7 5/8" Round U-bolt, (1) new 5/8" x 3 1/2" x 9 5/8" Round U-bolt, (4) 5/8" U-bolt High Nuts and (4) 5/8" U-bolt Washers. Working on the passenger side, install the new 5/8" x 3 1/2" x 9 5/8" round U-bolt into the stock location around the stock front differential inside location. Secure using the new U-bolt high nuts and washers. Secure the new 5/8" x 3" x 7 5/8" round U-bolt into the stock outside location. Secure using the new U-bolt high nuts and washers. Torque to **130 ft lbs.**

See Illustration # 5

14. Carefully remove both hydraulic floor jacks from under the front differential.

15. Locate (2) larger brake line relocation brackets, (2) 5/16" x 1" bolts, (4) 5/16" flat washers and (2) 5/16" unitorque nuts. Working on the driver side, secure the new brake line extending bracket to the stock location and secure using the new 5/16" x 1" bolt and hardware. Torque to **18 ft lbs. Make sure to use thread locker or locktite on these bolts.** Repeat procedure on the passenger side.

16. Working on the driver side, move the stock hard brake line located in the inner part of the frame rail under the stock frame. Reconnect the hard line and the soft line together back together around the new brake line extending bracket that was installed in step # 15. Repeat procedure on the passenger side.

See Illustration # 6

17. Working on the driver side, install the new front shocks absorbers using the stock hardware removed from step # 2 . **Special Note: Shocks are not included with this suspension system, shocks need to be ordered as a separate part number, Tuff Country EZ-Ride Suspension recommends using a 23" fully extended nitrogen gas shocks. If the vehicle that you are working on has the dual shock option, Tuff Country EZ-Ride Suspension recommends using a 26" fully extended cellular gas shock for the auxiliary shock.** Repeat procedure on passenger side.

See Illustration # 6

18. Install the tires and wheels and carefully lower the vehicle to the ground.

19. With the weight of the vehicle on the ground, torque the top and bottom spring eye shackle bolts on the driver and passenger side to **40 ft lbs.**

Front End Installation Complete

Rear End Installation

20. To begin installation, block the front tires of the vehicle so that the vehicle is stable and can't roll forward. Safely lift the rear of the vehicle and support the frame with a pair of jack stands. Place a jack stand on both the driver and passenger side. Next remove the wheels and tires from both sides.

21. Locate (1) rear brake line extending bracket, (1) 5/16" x 1" bolt, (2) 5/16" flat washers, (1) 5/16" unitorque nut and (1) 5/16" lock washer. Remove the stock brake line bracket from the rear differential and save stock bolt for later re-installation. Secure the new brake line bracket to the rear differential housing using the stock bolt. **Special Note: Make sure to use thread locker or lock tite.** Next, attach the stock brake line bracket to the newly installed brake line bracket and secure using the new 5/16" x 1 1/4" bolt and hardware. **Torque to 16 ft. lbs.**

See Illustration # 7

22. Position a pair of hydraulic floor jacks under the rear axle. Place one jack stand on the driver side and one on the passenger side. Raise up on both hydraulic floor jacks at the same time until they make contact with the rear axle.

23. Working on the driver side, remove the stock shock and save the stock hardware for later re-installation. Longer shocks are needed, so the stock shocks may be discarded. Repeat procedure on passenger side.

24. Working on the driver side, remove the (2) stock rear U-bolts and discard. Set the upper U-bolt plate a side for later re-installation. Repeat procedure on passenger side

25. Lower down on both hydraulic floor jacks at the same time until the stock springs separate from the stock rear axle. Lower down approximately 5". **Special Note: Make sure not to over extended any brake lines or hoses when lowering the axle.** This will allow you enough room for the new rear blocks to be installed.

26. Locate (2) new 4" lifted rear blocks. Working on the driver side, install (1) new 4" lifted block between the stock rear axle and the stock spring assembly. **Special Note: The new 4" lifted block has a slight taper to it, the small end of the new block needs to be installed with the small end towards the front of the vehicle.** Repeat procedure on passenger side.

See Illustration # 8

27. Raise up on both hydraulic floor jacks at the same time until the driver and passenger side stock spring assembly seats flush with newly installed 4" block.

28. Locate (4) new 5/8" x 3 1/2" x 12 1/2" Round U-bolts, (8) 5/8" U-bolt high nuts, (8) 5/8" U-bolt washers and the stock upper U-bolt plates that were removed from step

24. Working on the driver side, install (2) new 5/8" x 3 1/2" x 12 1/2" round U-bolts into the stock location and secure using the new 5/8" high nuts and washers. **Torque to 130 ft lbs.** Repeat procedure on passenger side. **Special Note: With a suitable cutting tool, cut off the excess U-bolt threads on all (4) rear U-bolts.**

See Illustration # 8

29. Working on the driver side, install the new rear shocks absorbers using the stock hardware removed from step # 23. **Special Note: Shocks are not included with this suspension system, shocks need to be ordered as a separate part number, Tuff Country EZ-Ride Suspension recommends using a 30" fully extended nitrogen gas shocks.** Repeat procedure on passenger side.

See Illustration # 8

30. Check and double check to make sure that all step related with the front and rear end were performed properly. Check and double check to make sure that all stock and new hardware is torque to proper torque specifications. Use the torque sheet at the beginning of the installation manual.

31. Install the tires and wheels and safely lower the vehicle to the ground.

32. Once the installation is complete, make sure to bleed the brake lines. Also, using the proper brake fluid, make sure to top off the brake fluid level.

CONGRATULATIONS INSTALLATION COMPLETE

Special Note: After the completion of the installation, Tuff Country EZ-Ride Suspension recommends taking the vehicle to an alignment shop and having a proper front end alignment performed.

It is also a good idea to keep a close watch on the front and rear drive line U-joints. If they start to wear out, make sure to replace them.

If you have any questions or concerns, please feel free to contact Tuff Country or your local Tuff Country dealer.

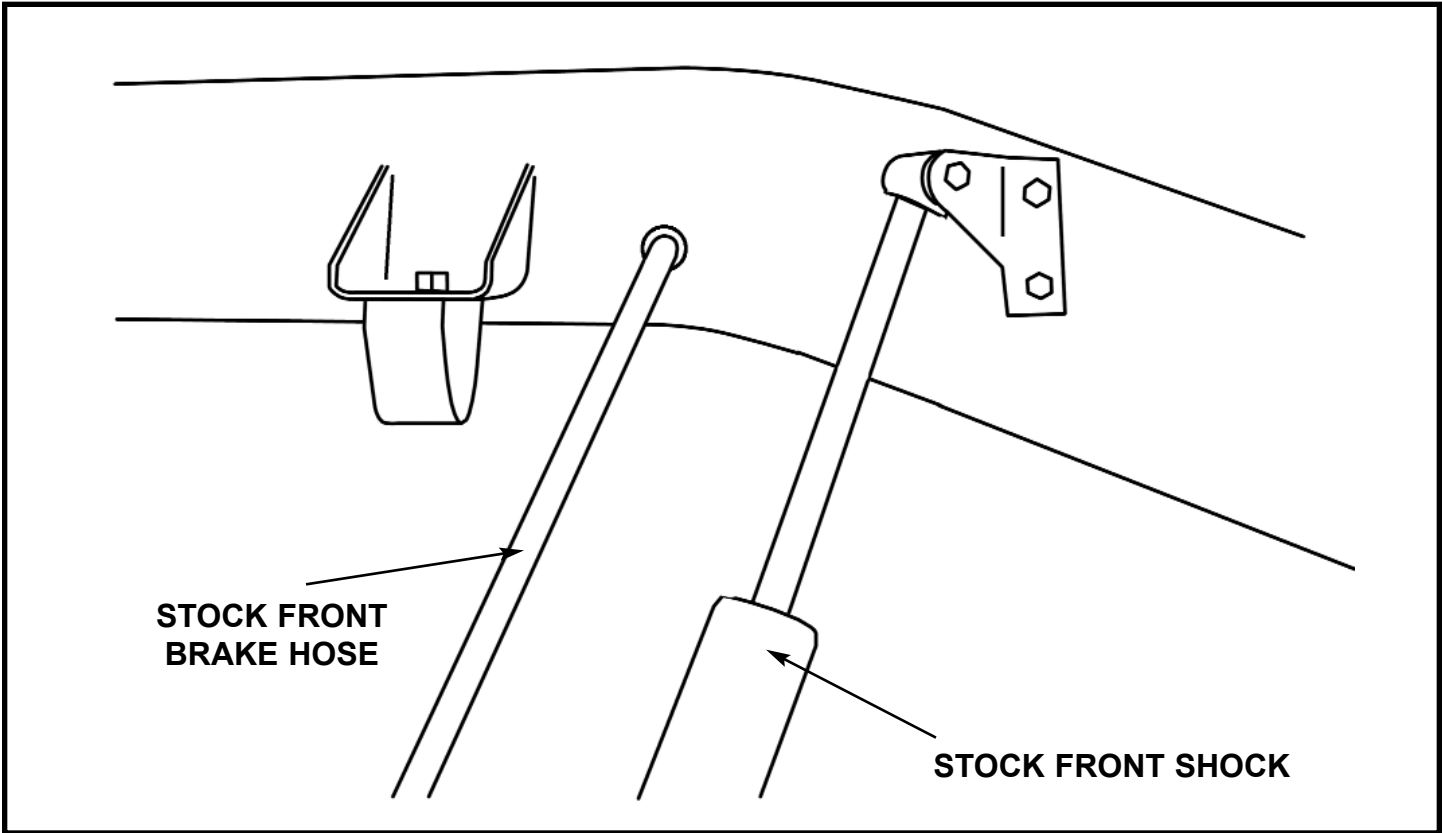

ILLUSTRATION # 1

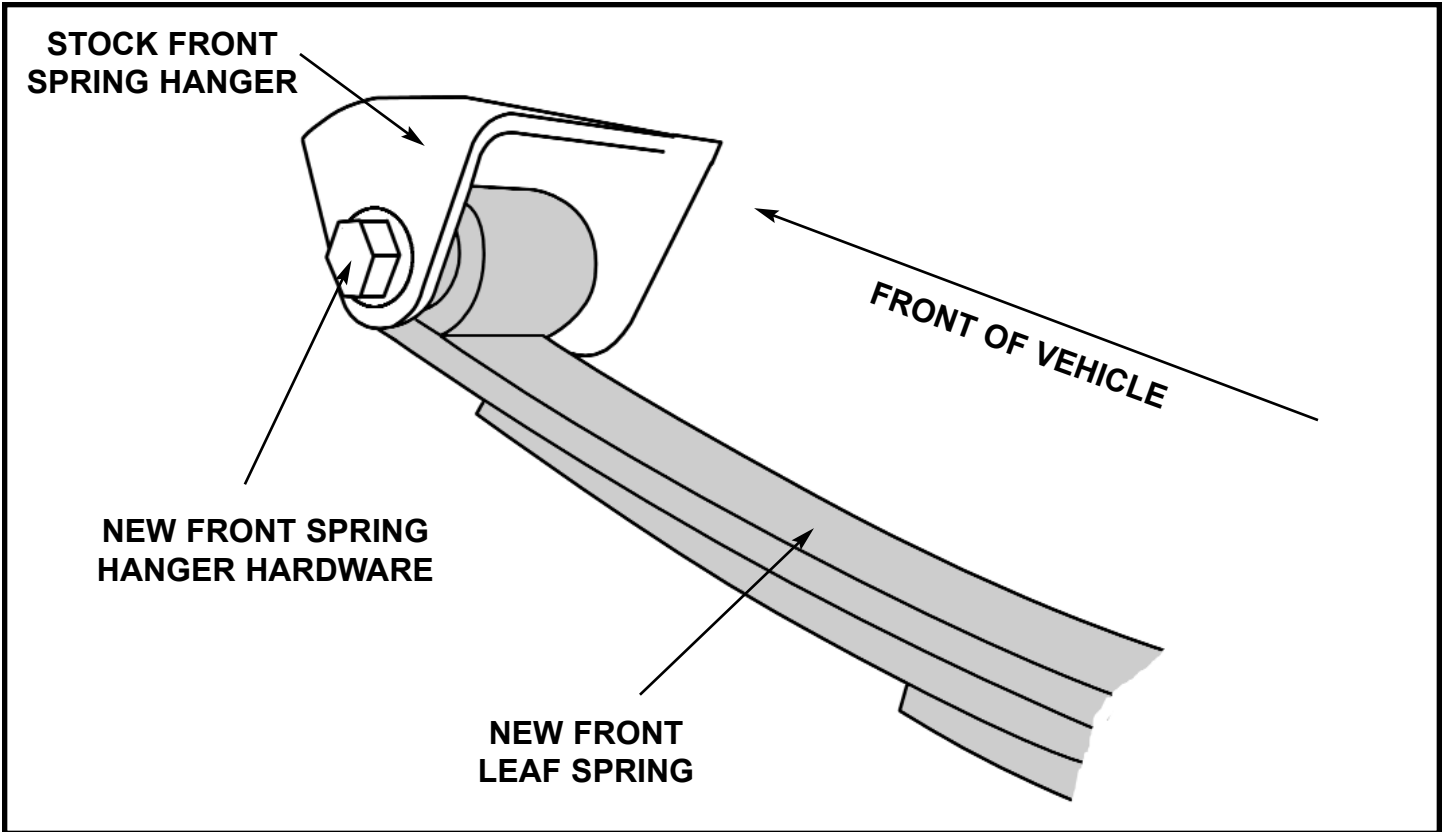

ILLUSTRATION # 2

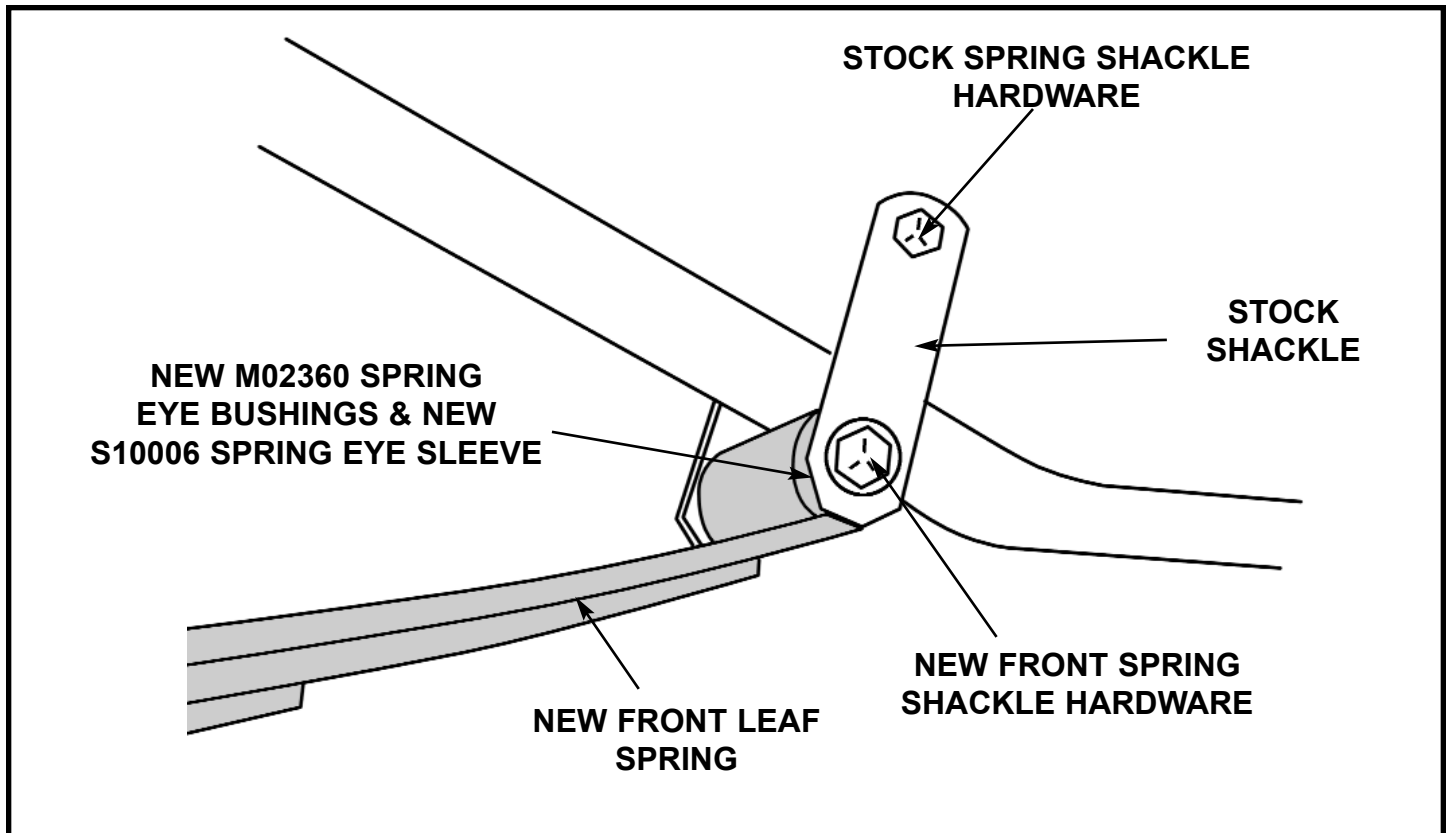

ILLUSTRATION # 3

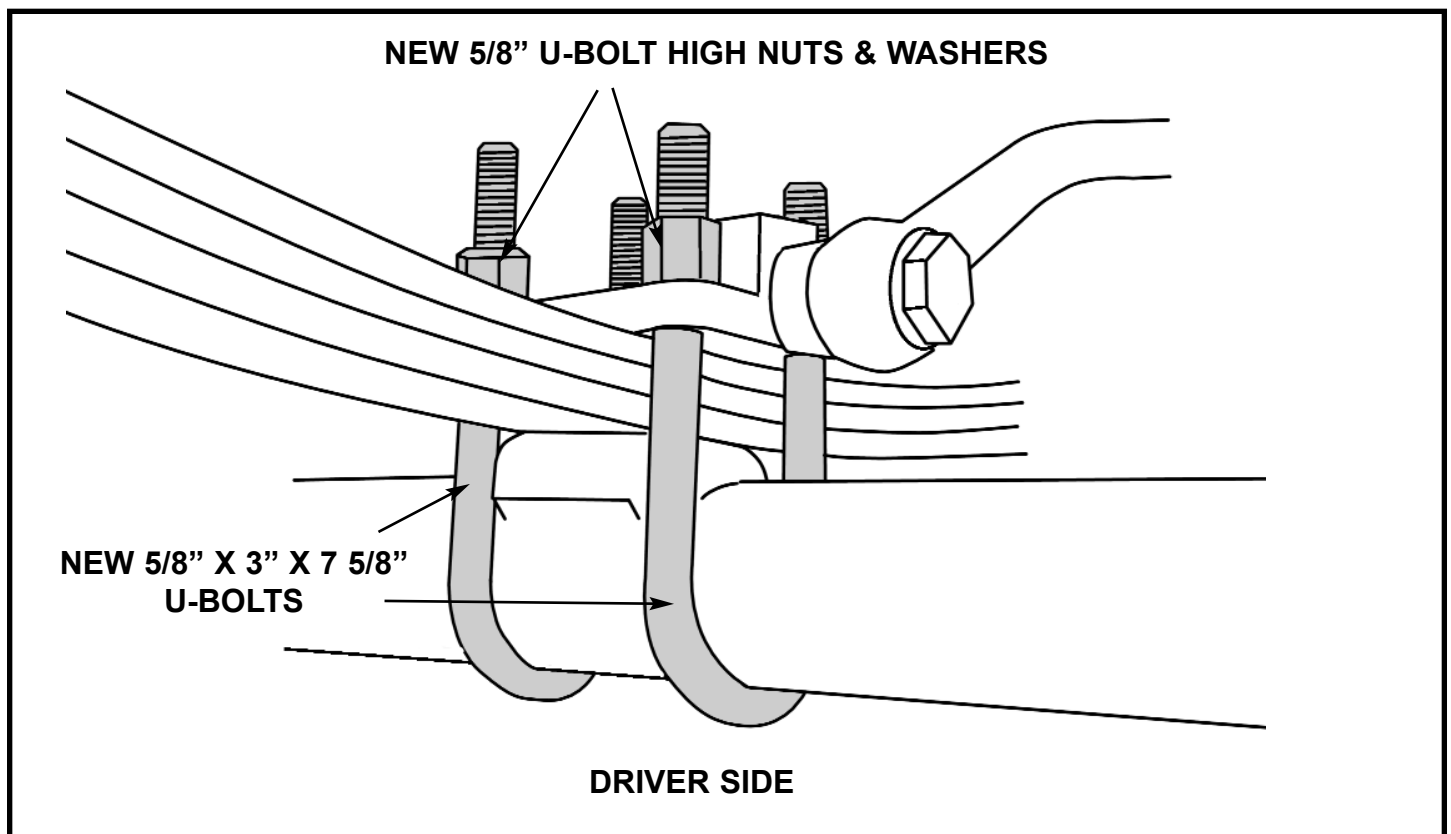

ILLUSTRATION # 4

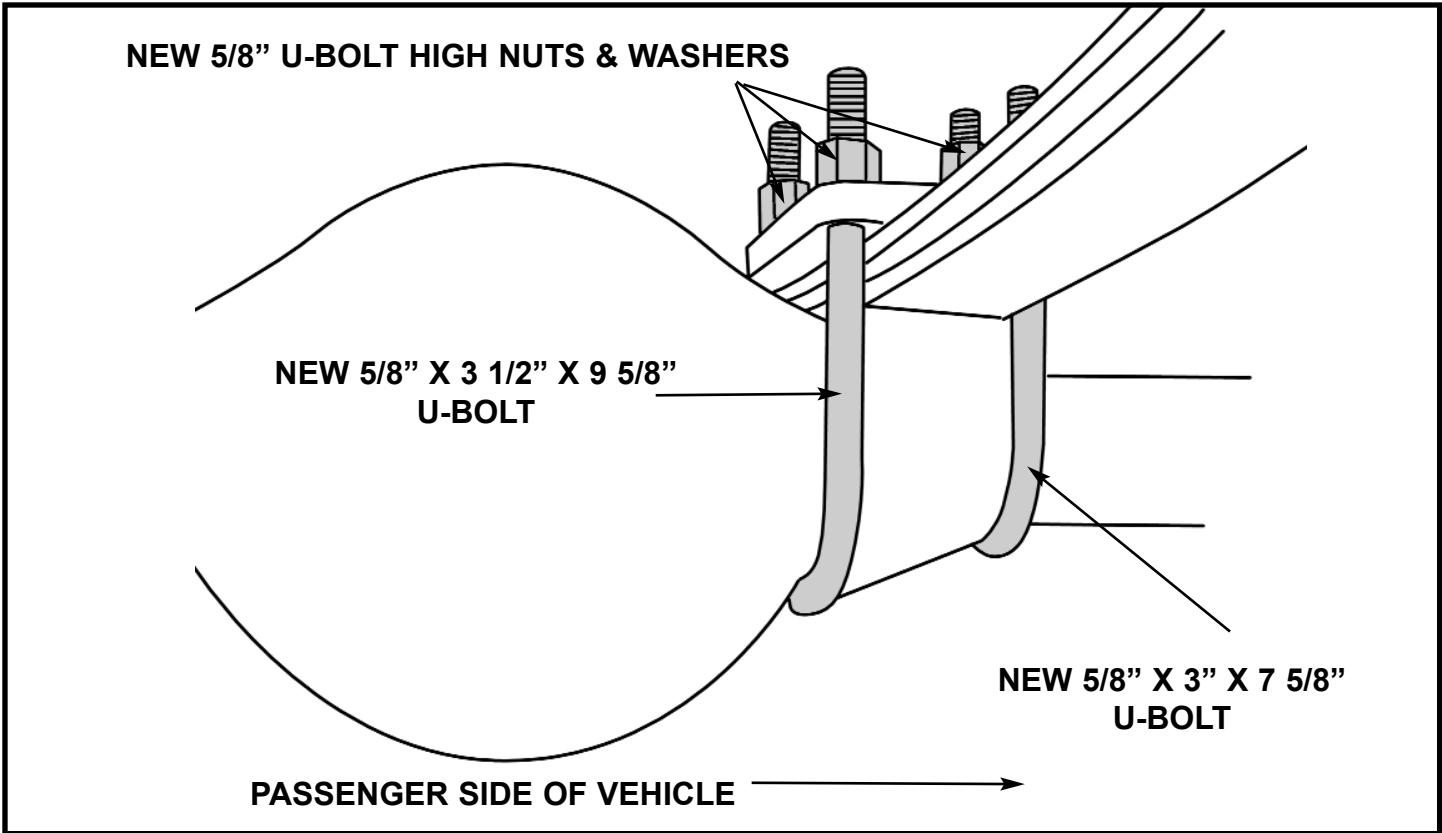

ILLUSTRATION # 5

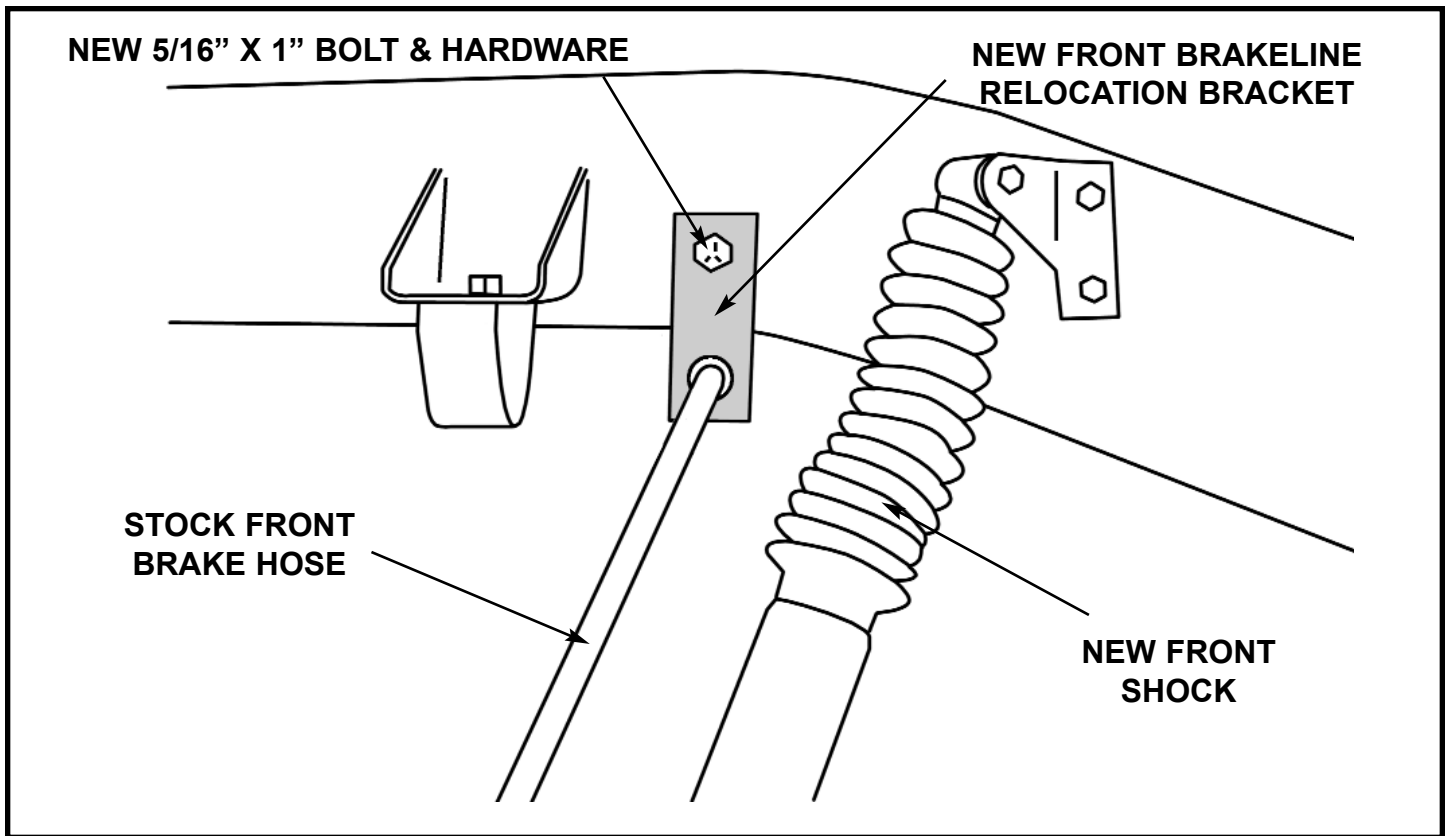

ILLUSTRATION # 6

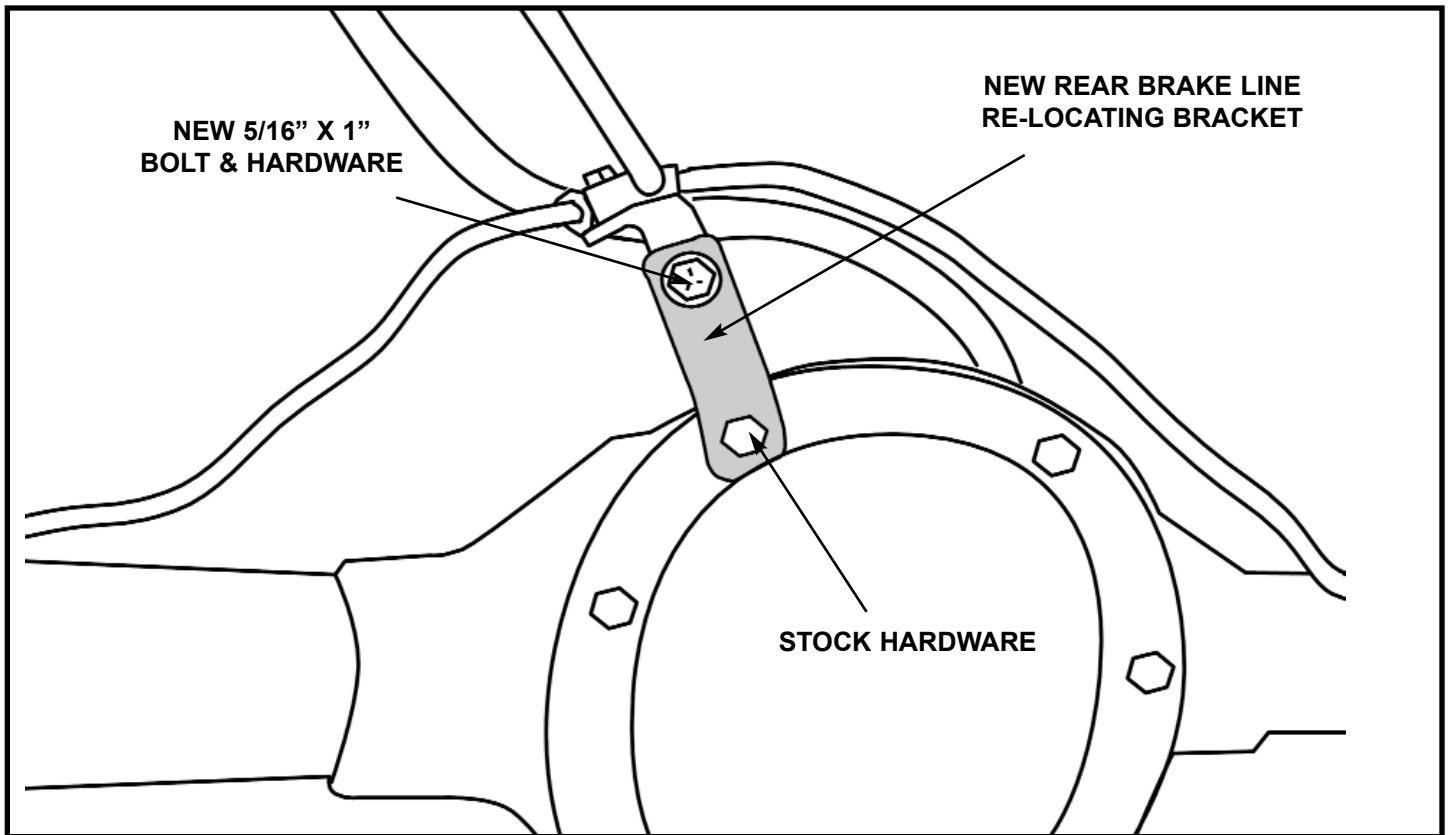

ILLUSTRATION # 7

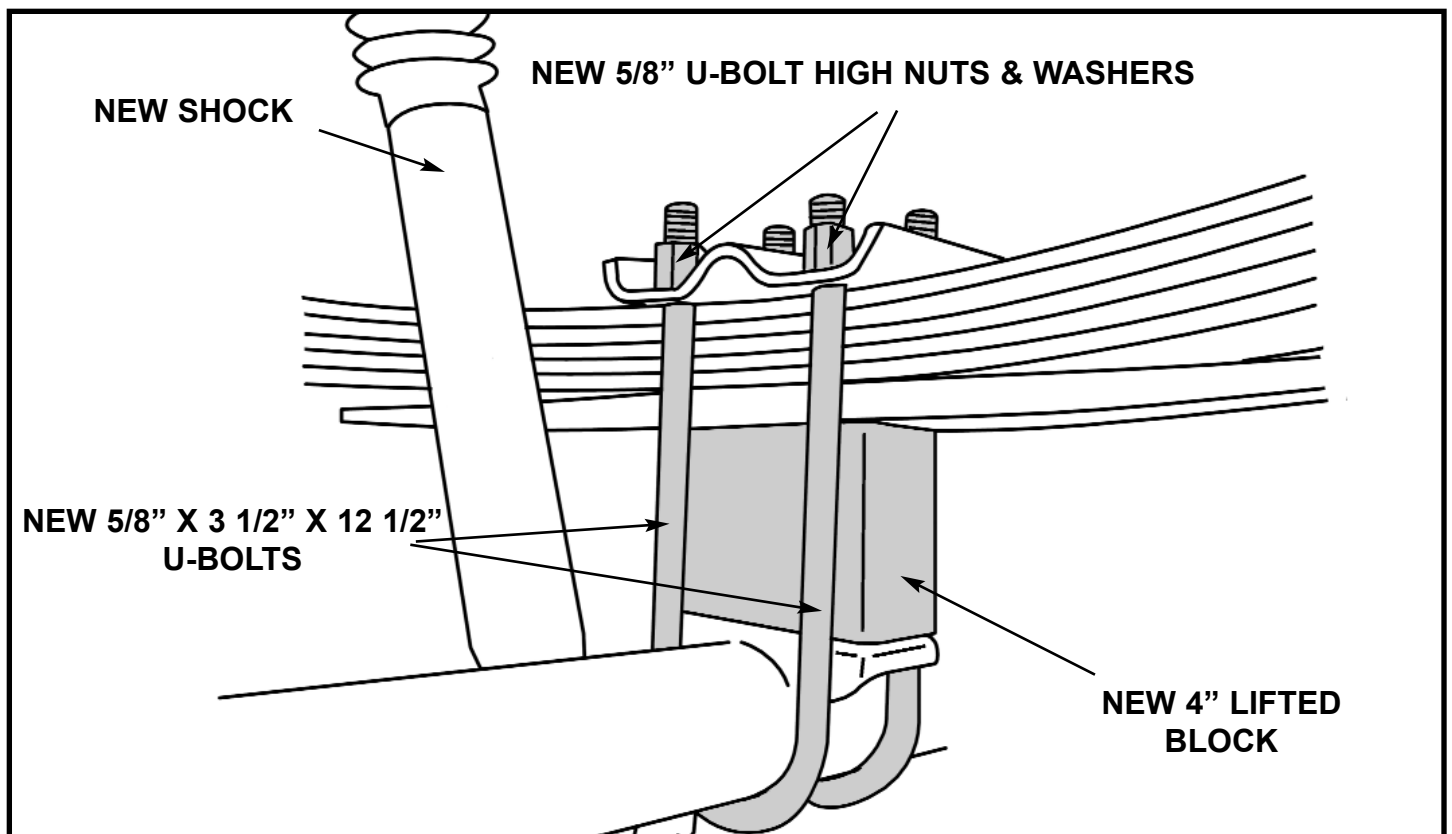

ILLUSTRATION # 8