

Installation Instructions
3000 Series StepGuard Part # 3173B & 3173C
2015 Chevrolet Silverado 2500HD & 3500HD 2/4WD

(Excludes models with Driver Alert Package)

Do not attempt to install this product on any vehicle other than the one listed above!

Parts List

Item	Qty.	Part #	Description	Torque
1	2	3171	Side Plate	
2	1	TT3700	Top Tube	
3	1	CP3700	Center Plate	
4	1	ST3700	Bottom Step Tube	
5	8		3/8" x 1 1/4" Hex Bolt	30 Ft. Lbs
6	4		3/8" Flat Washer	
7	8		3/8" Lock Washer	
8	4		3/8" Hex Nut	

Assembly & Installation Tools Required
10mm, 18mm, 7/16", 9/16" & 3/4" Socket
18mm, 7/16", 19/16" & 3/4" Wrench
Phillips & Flat Blade Screw Driver
Ratchet & Ratchet Extension

Read the assembly and installation instructions completely and verify that all of the parts listed are accounted for. If you have defective, missing or damaged parts or need assistance, please contact *Go Rhino Products* for fast, friendly customer service at: 1-888-427-4466 or email: warranty@gorhino.com

- Step-1** Begin the assembly by laying out the grille guard components on a protective surface.
- Step-2** Position the side plate's front edge down, and the top tube, center plate and bottom step tube between the side plates. Attach the top tube to each side plate using (1) 3/8" x 1 1/4" hex bolt and (1) 3/8" lock washer, center plate using (2) 3/8" x 1 1/4" hex bolts, (2) 3/8" flat washers, (2) 3/8" lock washers and (2) 3/8" hex nuts, and the bottom step tube using (2) 3/8" x 1 1/4" hex bolts and (2) 3/8" lock washers.
- Step-3** Align the grille guard assembly and tighten all nuts and bolts.

Assembly Diagram

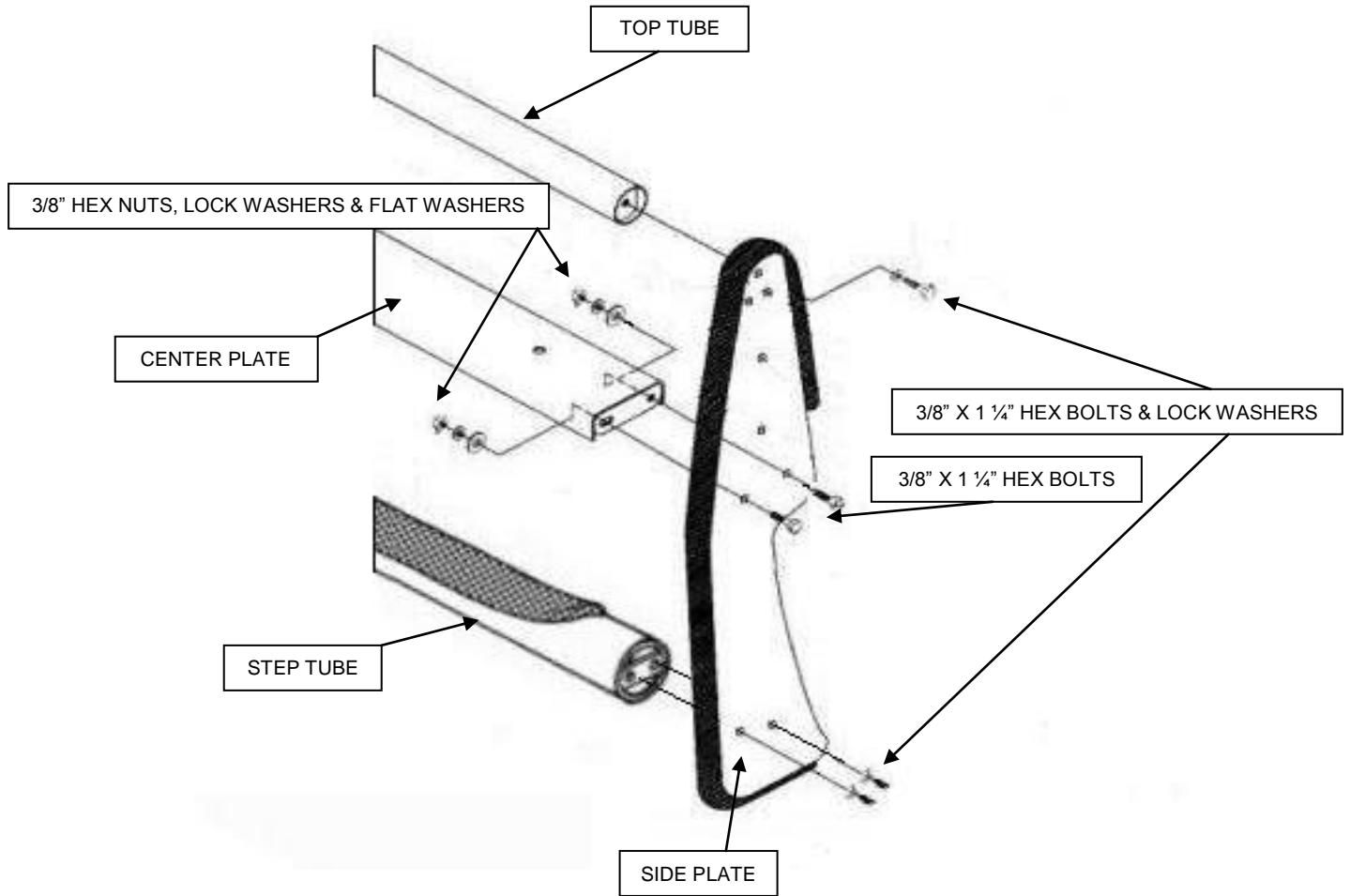

Installation Instructions
3000 Series StepGuard Part # 3173B & 3173C
2015 Chevrolet Silverado 2500HD & 3500HD 2/4WD

(Excludes models with Driver Alert Package)

Do not attempt to install this product on any vehicle other than the one listed above!

Parts List

Item	Qty.	Part #	Description	Torque
1	1 Pair	575796AA	Upper Bracket	
2	1 Pair	504794AA	Lower Bracket	
3	1	502766AA	License Plate Bracket	
4	2		1/4" x 3/4" Hex Bolt	10 Ft. Lbs.
5	2		1/4" Hex Nut	
6	8		1/2" x 1 1/2" Hex Bolt	65 Ft. Lbs.
7	8		1/2" Flat Washer	
8	8		1/2" Lock Washer	
9	8		1/2" Hex Nut	

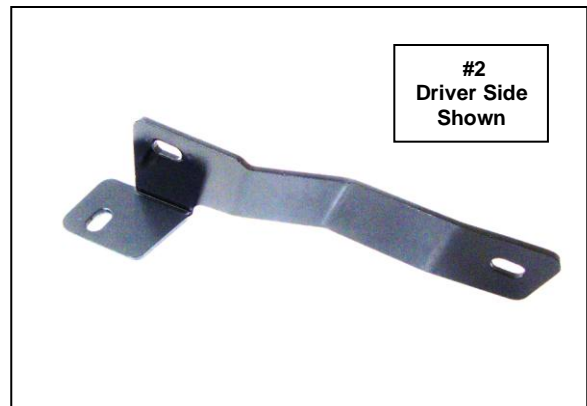
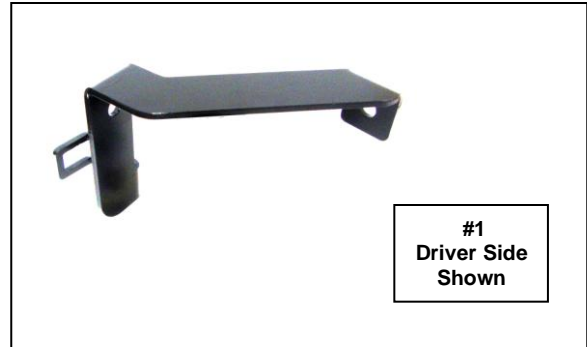

Installation

Step-1 Begin by removing the nut bolts and tow hook from the driver side frame, **(Photo 1 & 2)**. **Note:** The tow hook will be reinstalled.

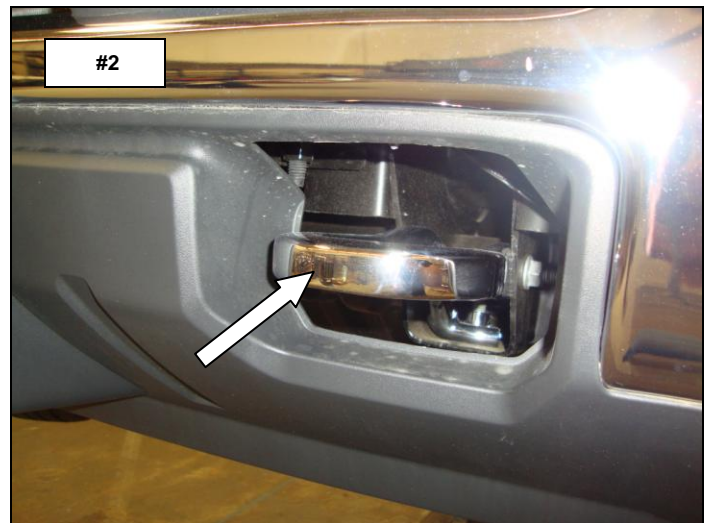
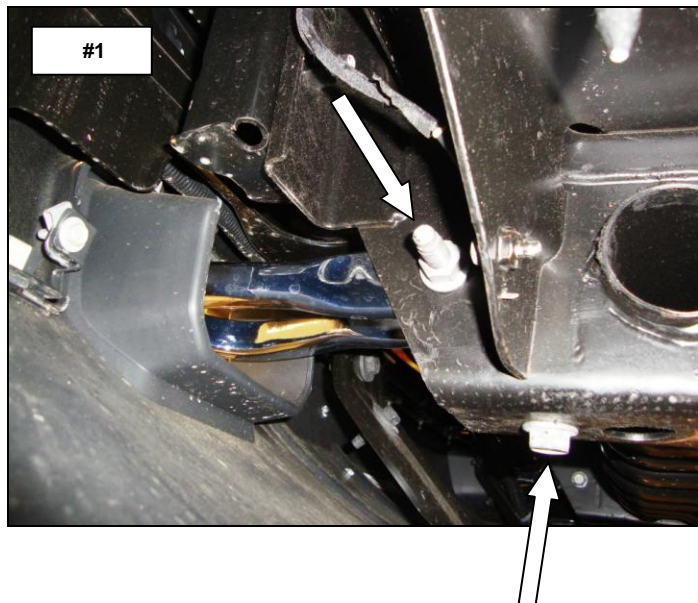

Step-2 From behind the bumper valance, position the driver side lower bracket so the leg of the bracket extends out through the tow hook opening, then rotate and align the bracket with the side and bottom of the frame. Reposition the tow hook inside the frame, align the lower bracket and tow hook with the holes in the frame and reinstall the tow hook bolts and nut, **(Photo 3 & 4)**. Leave the nut and bolts loose for final adjustment. Repeat the above steps to install the passenger side lower bracket.

Note: if your vehicle is not equipped with factory tow hooks, attach the lower brackets to the frame using the 1/2" x 1 1/2" hex bolts, flat washers, lock washers and hex nuts supplied.

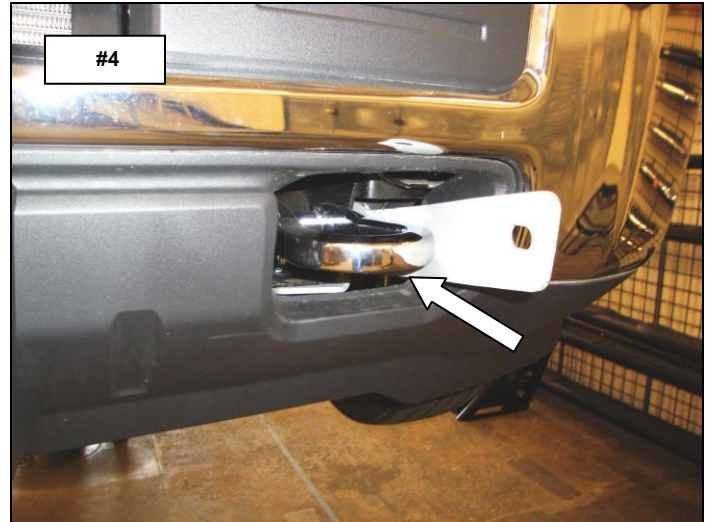
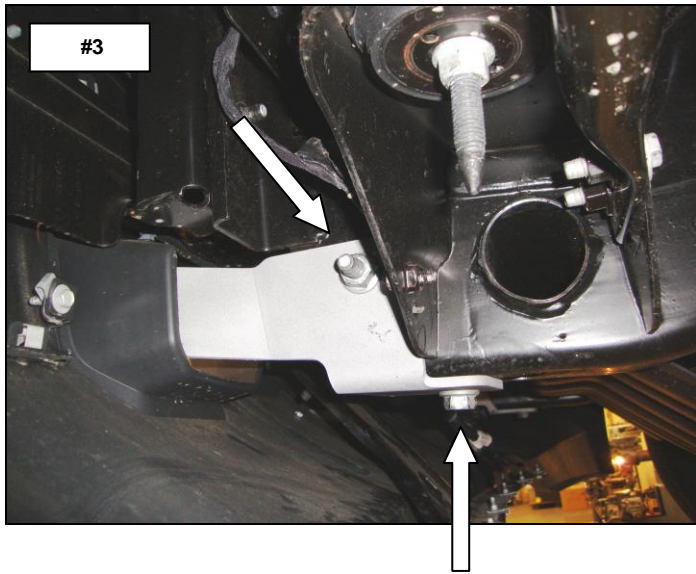

Step-3 Open the hood and locate the (12) plastic push pins (6) per side securing the radiator cover. Using a flat blade screw driver, pull the head of the push pins up, remove push pins and lift radiator cover off. This will allow access to the bolts securing the top of the grille, **(Photo 5)**.

Step-4 Remove the (4) screws (2) per side securing the top of the grille, **(Photo 6)**.

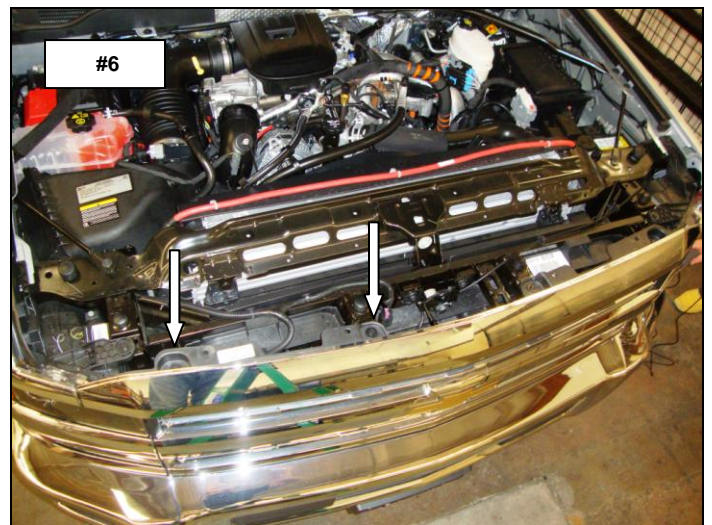
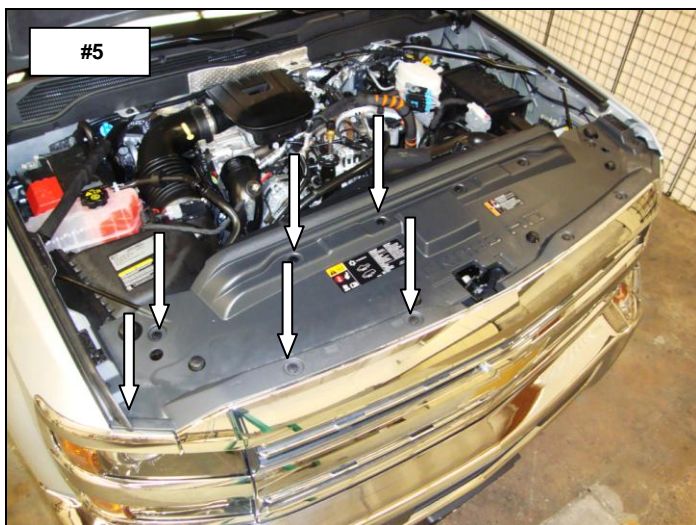

Step-5 Working from one side gently pull outward to unsnap the clips and remove the grille, **(Photo 7)**.

Step-6 Locate and remove the bolt connecting bumper to the bumper bracket and bolt connecting the bumper bracket to the frame on the driver side of the vehicle, **(Photo 7 & 8)**.

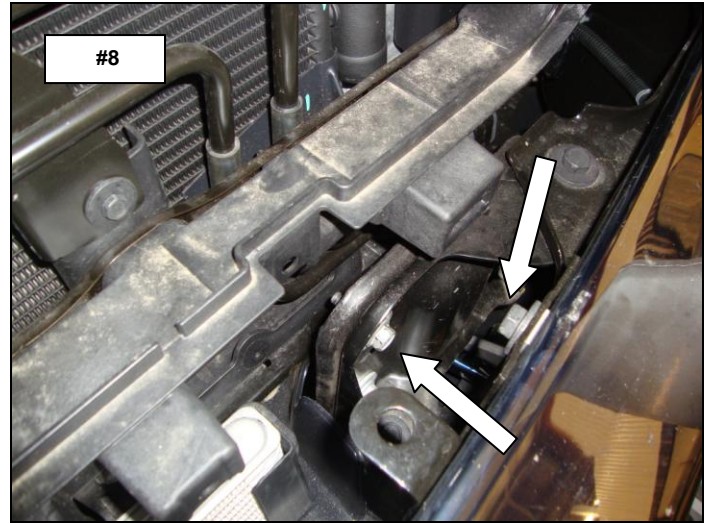
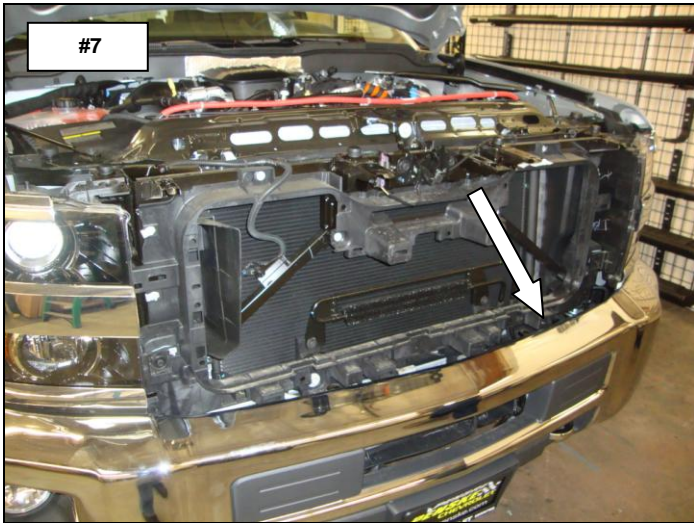

Step-7 position the driver side upper bracket behind the bumper, align the bracket with the hole in the bumper and bumper frame bracket then reinstall and tighten the bolts, **(Photo 9 & 10)**. Repeat the above steps to install the passenger side upper bracket then reinstall the vehicle's grille, radiator cover.

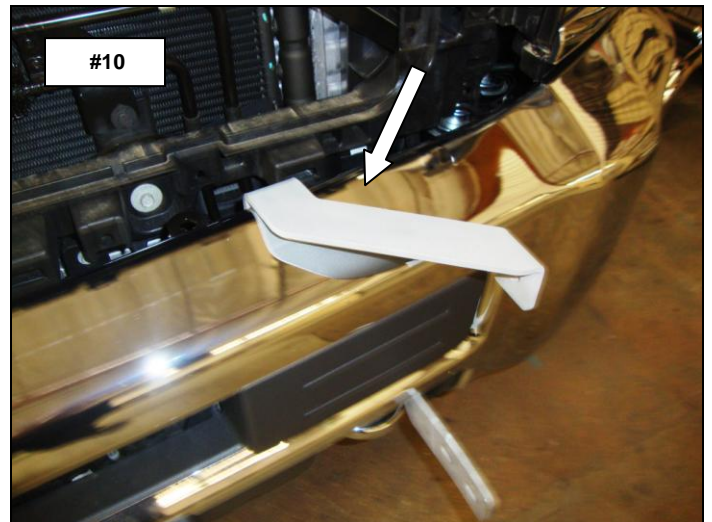
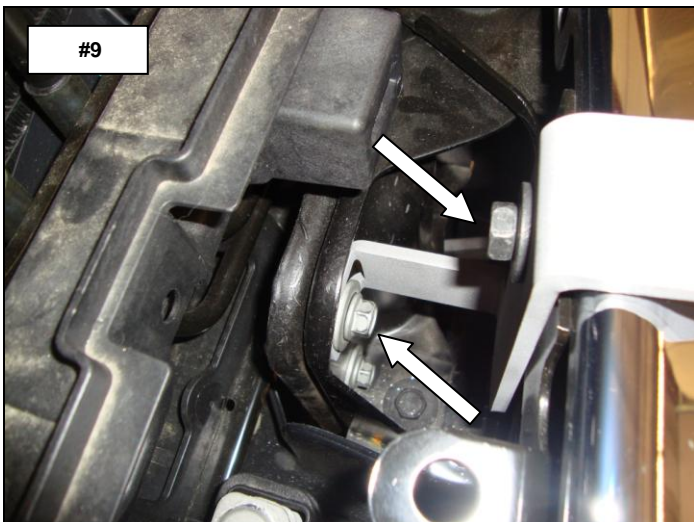

Step-8 Position the grille guard up to the brackets and attach the grille guard to the outside of each bracket using the 1/2" x 1 1/2" hex bolts, 1/2" flat washers, 1/2" lock washers and 1/2" hex nuts supplied, **(Photo 11 & 12)**.

Step-9 Align the grille guard with the vehicle and tighten the factory and supplied nuts and bolts.



Step-10 If your state law requires a front license plate, attach the supplied bracket to the upper set of holes in the vehicle bracket using the factory license plate attachment screws. Attach the license plate to the supplied bracket using (2) 1/4" x 3/4" hex bolts and (2) 1/4" hex nuts, **(Photo 13)**.

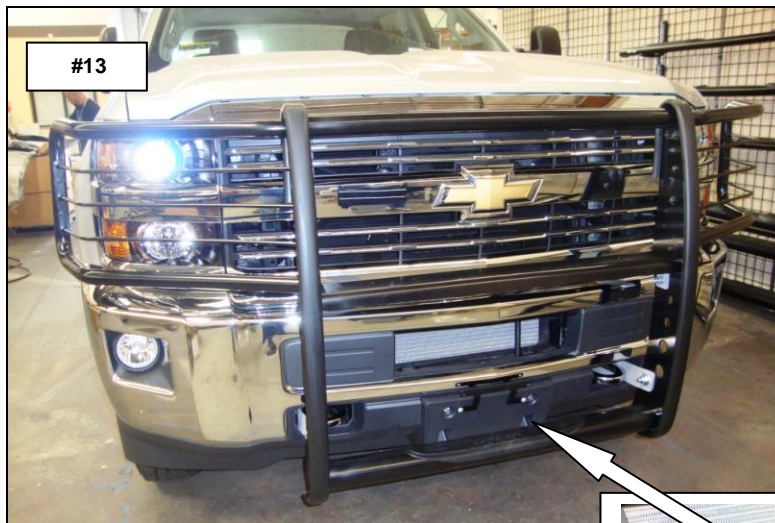

Remember to check and retighten all nuts and bolts hardware periodically.