



INTAKE SYSTEMS FOR VEHICLES LISTED ARE 50 STATE LEGAL. SEE KNFILTERS.COM FOR CARB STATUS ON EACH PART FOR A SPECIFIC VEHICLE.

INSTALLATION INSTRUCTIONS

57-2548
FORD
1999-00 Lightning
V8-5.4L Supercharged

NOTE: This kit was not designed to fit vehicles with a body lift.

TOOLS NEEDED:

- Flat Blad Screwdriver
- 10mm Socket
- 10mm Wrench
- 14mm Socket
- 13mm Wrench
- 4mm Allen
- Ratchet
- 5mm Allen
- Extension

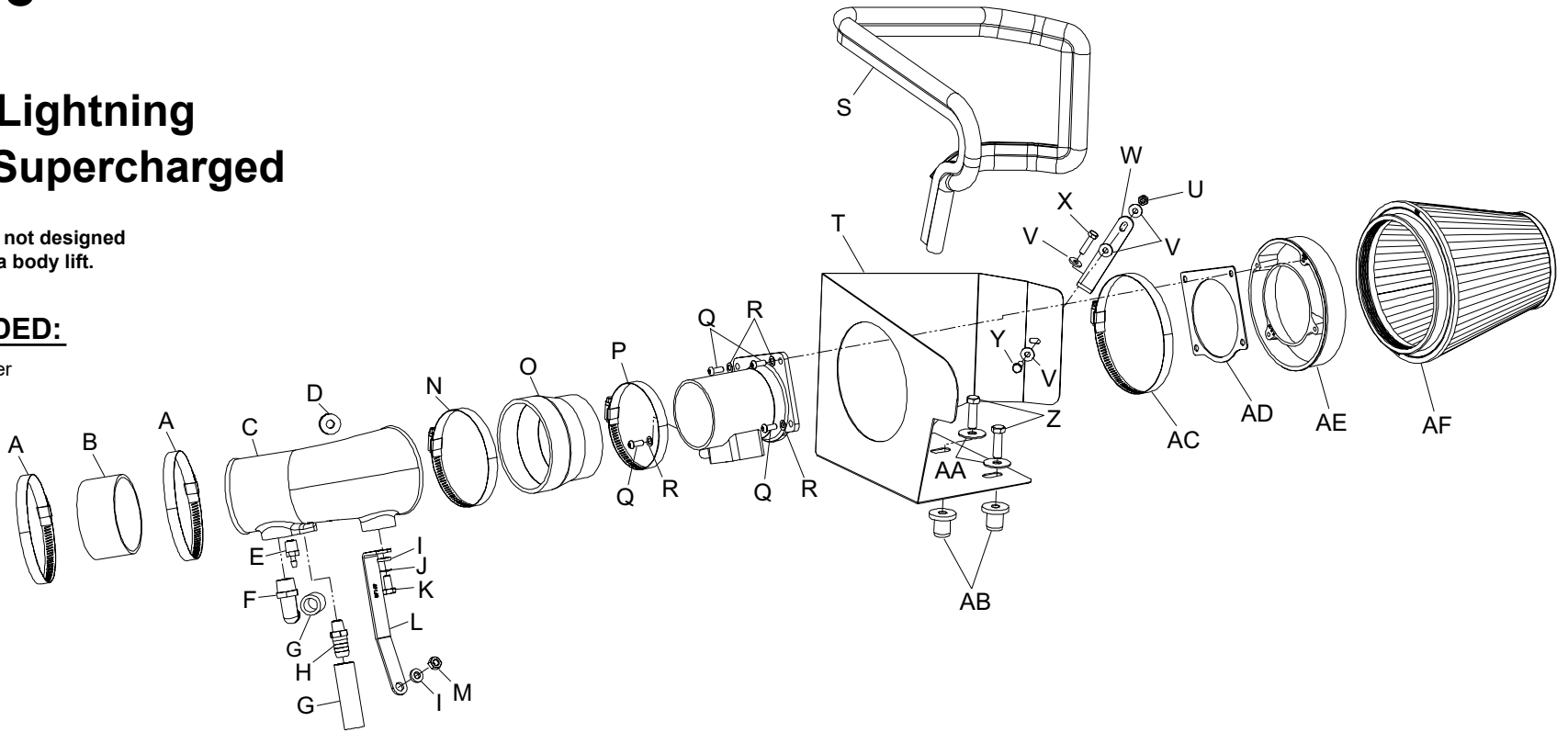

PARTS LIST:

Description	Qty.	Part #	Description	Qty.	Part #	Description	Qty.	Part #
A HOSE CLAMP #72	2	08671	L BRACKET "L" LONG	1	07169	W BRACKET "L"	1	070952A
B HOSE; 4-1/2"ID X 1-3/4L	1	08540	M NYLOCK NUT 8MM	1	07542	X BOLT 6MM X 25MM	1	07704
C INTAKE TUBE (CX) SHORT	1	087092A	N HOSE CLAMP #64	1	08648	Y BOLT; 6MM X 16MM	1	07703
D GROMMET, 3/8"ID	1	08100	O SILICONE STEP HOSE	1	08050	Z BOLT; 3/8" X 1.25"	2	07779
E VENT; 3/16 BARBED 1/4"NPT	1	080021	P HOSE CLAMP #56	1	08620	AA FENDER WASHER	2	08126
F VENT; 90 DEG, 5/8"X1/2"NPT	1	08040FK	Q BUTTON HEAD ALLEN M6	4	07730	AB INSERT, 3/8"	2	08163
G SILICONE HOSE 5/8"ID X 3"	2	08464	R WAVE WASHER 6MM	4	08174	AC HOSE CLAMP #104	1	08697
H VENT; 5/8 BARBED, 1/4 NPT	1	08911-1	S EDGE TRIM 55"	1	102480	AD MASS AIR GASKET	1	09984
I FLAT WASHER 5/16"	2	08276	T HEAT SHIELD	1	07483	AE FILTER ADAPTOR #250	1	08785A
J WAVE WASHER 8MM	1	08239	U NYLOCK NUT 6MM	1	07553	AF AIR FILTER	1	RU-5046
K BOLT 8MM X 16MM	1	07844	V FLAT WASHER 1/4" X 5/8"OD	4	08275			

NOTE: FAILURE TO FOLLOW INSTALLATION INSTRUCTIONS AND NOT USING THE PROVIDED HARDWARE MAY DAMAGE THE INTAKE TUBE, THROTTLE BODY AND ENGINE.

TO START:

1. Turn off the ignition and disconnect the negative battery cable.
NOTE: Disconnecting the negative battery cable erases pre-programmed electronic memories. Write down all memory settings before disconnecting the negative battery cable. Some radios will require an anti-theft code to be entered after the battery is reconnected. The anti-theft code is typically supplied with your owner's manual. In the event your vehicles' anti-theft code cannot be recovered, contact an authorized dealership to obtain your vehicles anti-theft code.

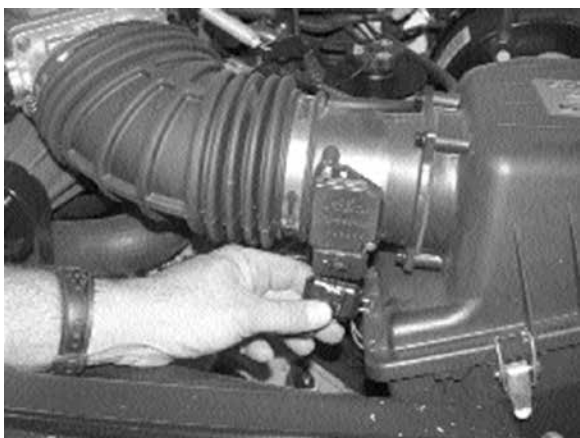

2. Disconnect the mass air sensor electrical connection.



3. Loosen the hose clamp at the throttle body and mass air sensor as shown.



4. Remove the intake tube from vehicle.
NOTE: Disconnect the three vent lines under the intake tube before removing from vehicle.

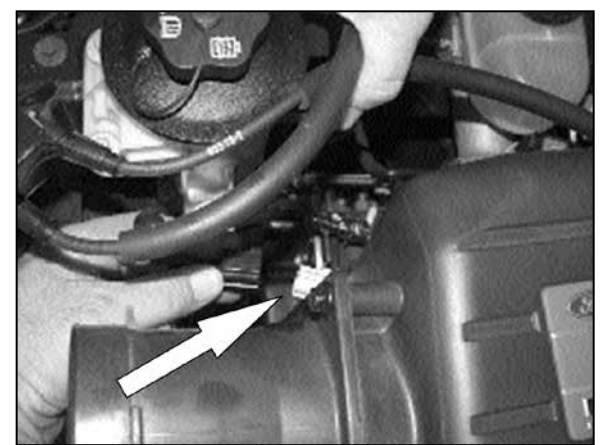

5. Disconnect the temp sensor electrical connection as shown.



6. Pull up firmly on the factory air box to remove from vehicle.
NOTE: K&N Engineering, Inc., recommends that customers do not discard factory air intake.

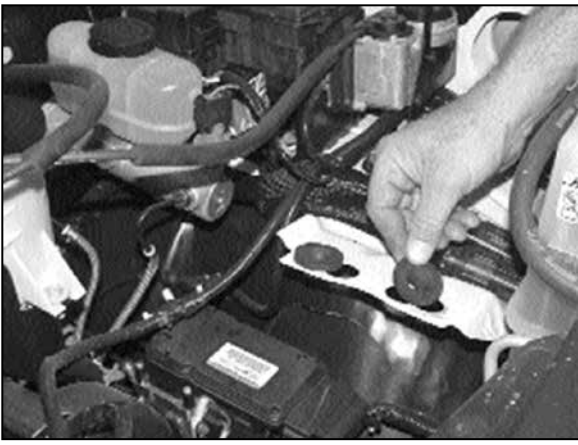

7. Remove the two air box mounting grommets from the air box mounting tray as shown.

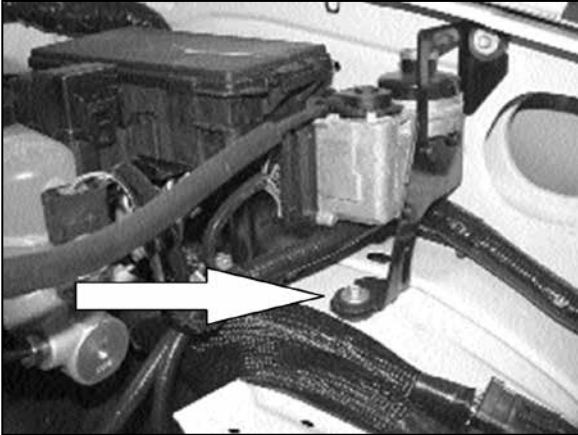

8. Remove the 6mm bolt that retains the cruise control onto vehicle.



9. Install edge trim onto the heat shield as shown. Trim if needed.

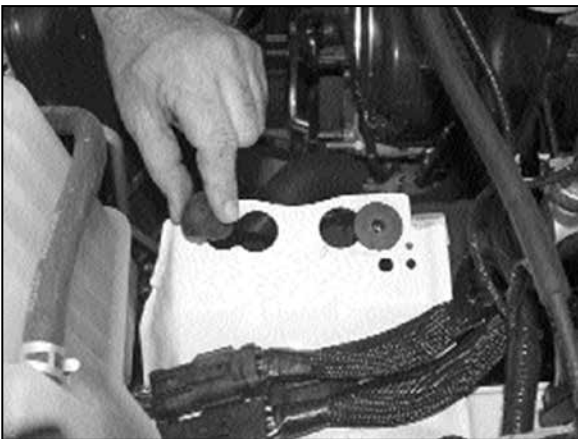

10. Install the two provided nut inserts onto the air box mounting tray as shown.



11. Install the "L" bracket onto heat shield as with the provided hardware as shown.
NOTE: Install a washer between the bracket and heat shield.

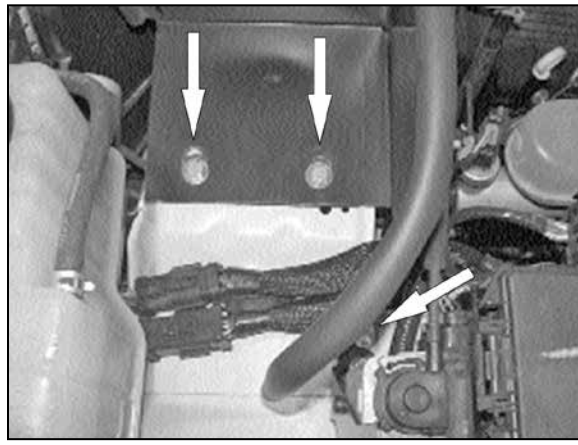

12. Install the heat shield into vehicle, then secure with the provided hardware as shown.

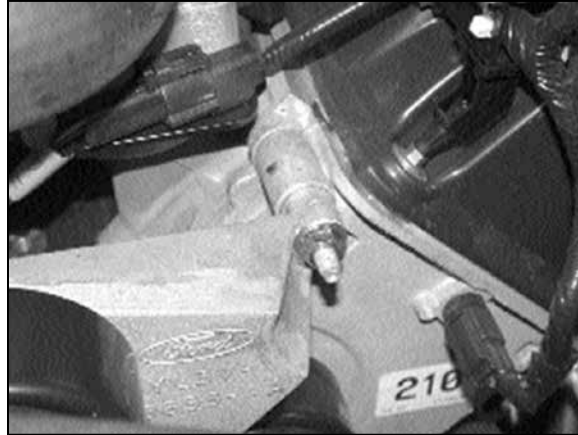

13. Remove the 8mm nut from stud that retains the idler pulley bracket.



14. Install the provided bracket onto the stud with the nut that was removed in the previous step.



15. Install the silicone hose (08540) onto the throttle body with the provided hose clamp as shown.



16. Install the provided vent fitting onto the new K&N® intake tube as shown.
NOTE: Plastic NPT fittings are easy to cross thread. Install the vent fitting "hand" tight, then turn it two complete turns with a wrench.

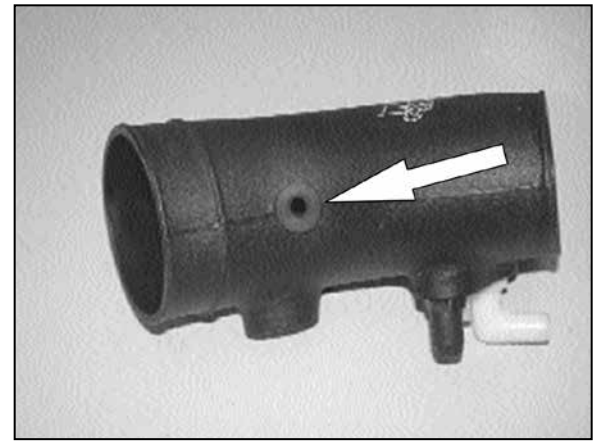

17. Install the provided grommet into the new intake tube as shown.



18. Remove the idle air vent tube from vehicle as shown.

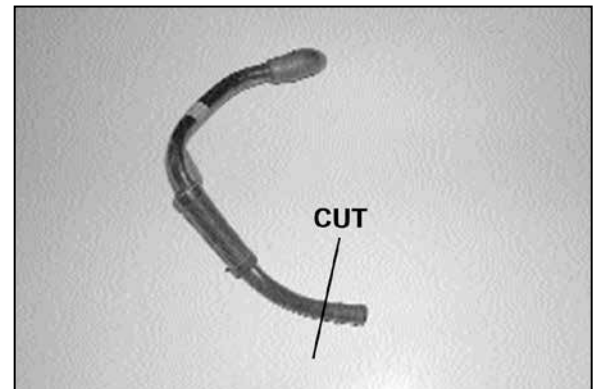

19. Cut the end off the idle air vent tube just below bead as shown. Then re-install vent tube back onto vehicle.

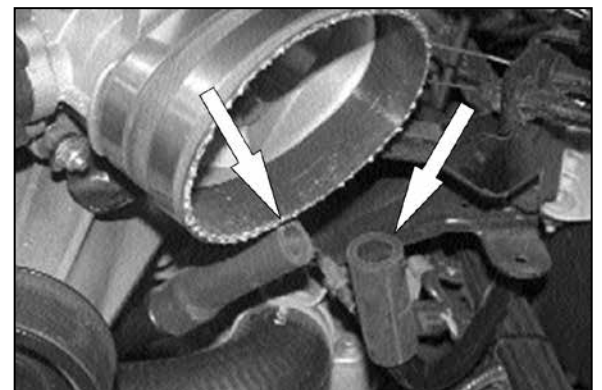

20. Install the two provide 5/8 silicone hoses onto the idle air and crank case vent lines as shown.



21. Install the new K&N® intake tube into the silicone and then tighten the provided hose clamp.
NOTE: Reconnect the three vent lines under the intake tube that were removed in step 4.

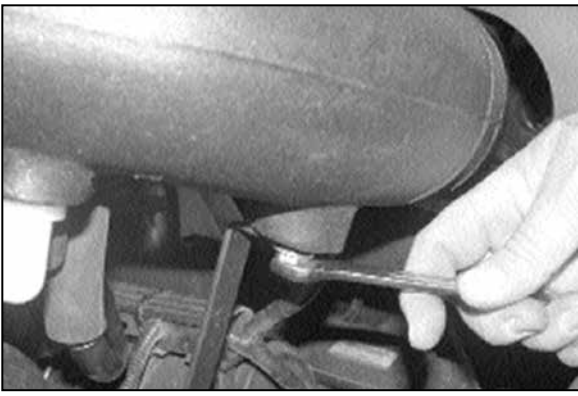

22. Connect the new intake tube to the bracket with the provided hardware as shown.

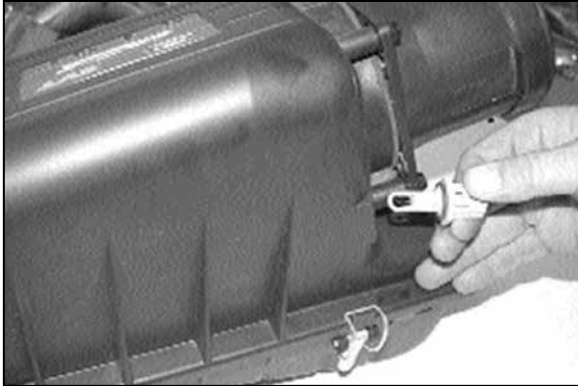

23. Remove the temp sensor from the factory air box as shown.



24. Install the temp sensor into the intake tube then reconnect the electrical connection as shown.

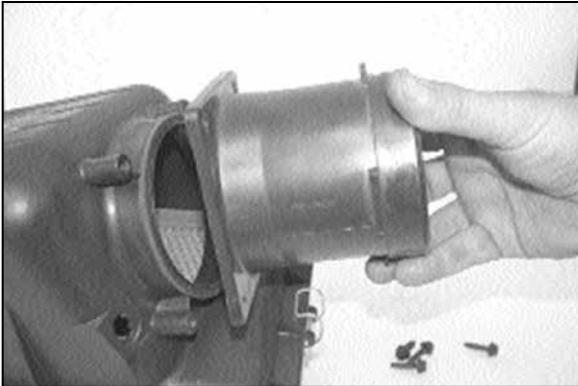

25. Remove the mass air sensor from the factory air box as shown.

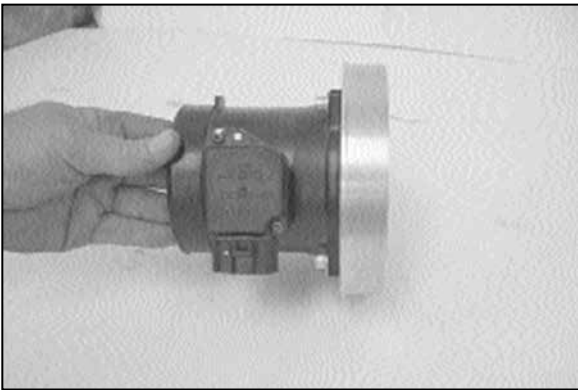

26. Assemble the filter adaptor and gaskets onto the mass air sensor with the provided hardware as shown.

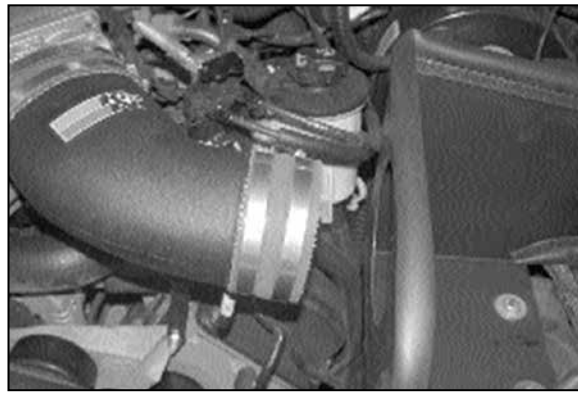

27. Install the silicone hose (08050) onto the intake tube with the provided hose clamps.

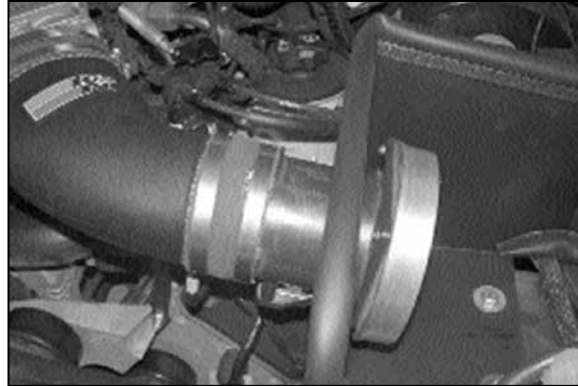

28. Install the mass air sensor assembly onto the intake tube, then secure with the provided hose clamp.

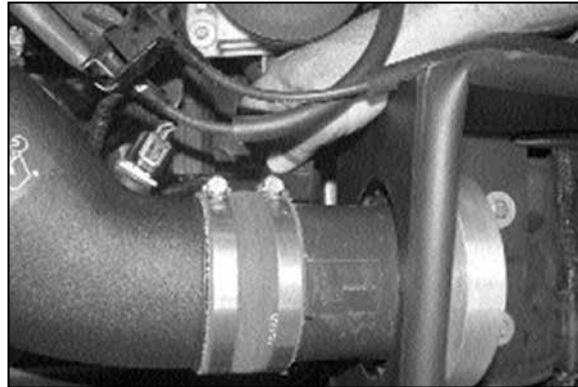

29. Reconnect the mass air sensor electrical connection as shown.



30. Install the Filtercharger onto the mass air adaptor and then secure it with the provided hose clamp.



31. It may be necessary to loosen the hardware and adjust the entire assembly to achieve proper clearances.

32. Reconnect the vehicle's negative battery cable. Double check to make sure everything is tight and properly positioned before starting the vehicle.

33. The C.A.R.B. exemption sticker, (attached), must be visible under the hood so that an emissions inspector can see it when the vehicle is required to be tested for emissions. California requires testing every two years, other states may vary.

34. It will be necessary for all K&N® high flow intake systems to be checked periodically for realignment, clearance and tightening of all connections. Failure to follow the above instructions or proper maintenance may void warranty.

ROAD TESTING:

1. Start the engine with the transmission in neutral or park, and the parking brake engaged. Listen for air leaks or odd noises. For air leaks secure hoses and connections. For odd noises, find cause and repair before proceeding. This kit will function identically to the factory system except for being louder and much more responsive.

2. Test drive the vehicle. Listen for odd noises or rattles and fix as necessary.

3. If road test is fine, you can now enjoy the added power and performance from your kit.

4. K&N Engineering, Inc., requires cleaning the intake system's air filter element every 100,000 miles. When used in dusty or off-road environments, our filters will require cleaning more often. We recommend that you visually inspect your filter once every 25,000 miles to determine if the screen is still visible. When the screen is no longer visible some place on the filter element, it is time to clean it. To clean and re-oil, purchase our filter Recharger® service kit, part number 99-5050 or 99-5000 and follow the easy instructions.

INTAKE SYSTEMS FOR VEHICLES LISTED ARE 50 STATE LEGAL. SEE KNFILTERS.COM FOR CARB STATUS ON EACH PART FOR A SPECIFIC VEHICLE.