

INSTALLATIONS INSTRUCTIONS
61248 SIDE BAR WHEEL TO WHEEL
FORD LOBO F-150 EXT. CAB 6.5 Ft 09 - 13

Parts list:

ITEM	QTY.	CODE	DESCRIPTION	TORQUE MAX.
1	1	373218AA-8CA	Side bar passenger side	-
2	1	373218AA-8CA	Side bar driver side	-
	1	BRK-37721	Brackets kit includes:	
3	1	372694AA	Front main bracket set	-
4	1	372692AA	Front auxiliary bracket set	-
5	1	373264AB	Rear main bracket set	-
6	2	3713312	5/16" bolt plate	11 Lb.Ft
7	2	378312	1/2" bolt plate	75 Lb.Ft
	1	KTE-37721	Hardware kit includes:	
8	2	-	1/2 x 2" Hex head bolt zinc plated	75 Lb.Ft
9	4	-	1/2" Flat washer zinc plated	-
10	4	-	1/2" Lock washer zinc plated	-
11	2	-	1/2" Hex nut zinc plated	75 Lb.Ft
12	2	-	5/16" Flat washer zinc plated	-
13	2	-	5/16" Lock washer zinc plated	-
14	2	-	5/16" Hex nut zinc plated	11 Lb.Ft
15	2	-	1/4 x 1" Hex head bolt black plated	9 Lb.Ft
16	4	-	1/4 Flat washer black plated	-
17	2	-	1/4 Lock washer black plated	-
18	2	-	1/4 Hex nut black plated	9 Lb.Ft
19	6	-	3/8 x 1 1/4" Hex head bolt black plated	30 Lb.Ft
20	2	-	3/8 x 1 1/4" Carriage head bolt black plated	-
21	8	-	3/8" Flat washer black plated	-
22	8	-	3/8" Lock washer black plated	30 Lb.Ft
23	2	-	3/8" Hex nut black plated	30 Lb.Ft
24	2	-	3/8" Clip nut	30 Lb.Ft

Required Tools (no included)

DESCRIPTION	QTY.
9/16" Socket / Wrench	1
3/4" Socket / Wrench	1
1/2" Socket / Wrench	1
7/16" Socket / Wrench	1
Ratchet	1
Ratchet extension	1

ILLUSTRATION 1

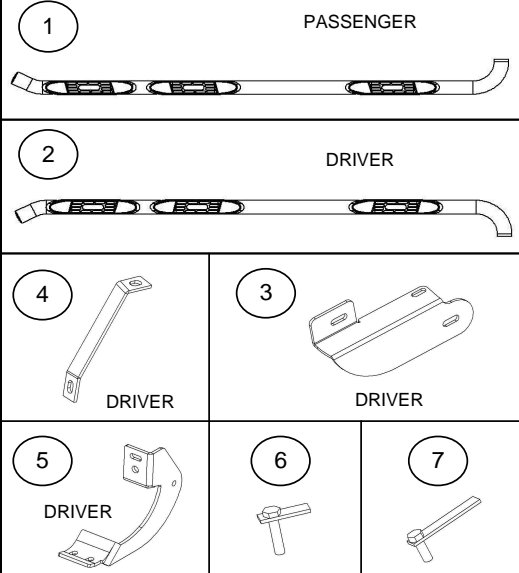

Approximate installation time: 40 min.

Instructions:

ILLUSTRATION 2.

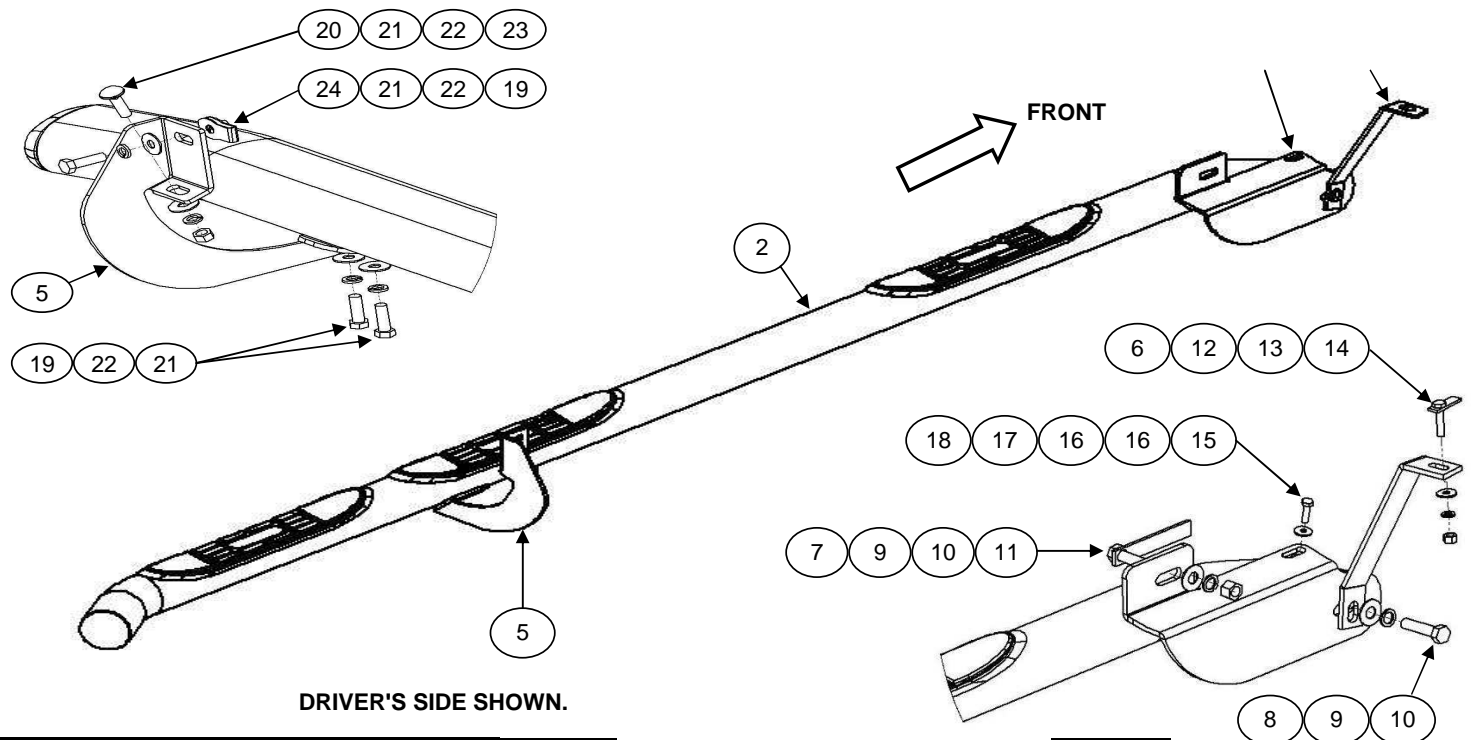

Cleaning and care instructions:

Keep your product clean. Do not use abrasive cleaners or polish. We recommend only non-abrasive automotive wax such as pure carnauba to avoid scratches or rust.

Design :

Quality:

INSTALLATIONS INSTRUCTIONS 61248 SIDE BAR WHEEL TO WHEEL

1. Before beginning the installation, please read all directions carefully and verify that all necessary hardware is accounted for. If any parts are missing, stop the installation and contact your distributor immediately.
2. To install front mounting bracket locate in the rocker panel the cover holes tape and remove it. Insert into the exposed round hole (1) 1/2" bolt plate. **See picture 1 & 2.**
 - a).- Remove the bolt and clip nut. **See picture 2.**
 - b).- Install the front mounting bracket using corresponding hardware. Leave loose. **See illustration 2.**
 - c).- Secure front mounting bracket's face towards the floor using (1) 1/4 x 1" hex head bolt with corresponding provided hardware. Leave loose. **See Illustration 2.**
3. To install front auxiliary mounting bracket locate and remove the cover tape behind the front mud guard and insert into the square hole (1) 5/16" bolt plate. **See picture 3.**
 - a).- Install the front auxiliary mounting bracket using corresponding hardware. Leave loose. **See illustration 2.**

PICTURE 1

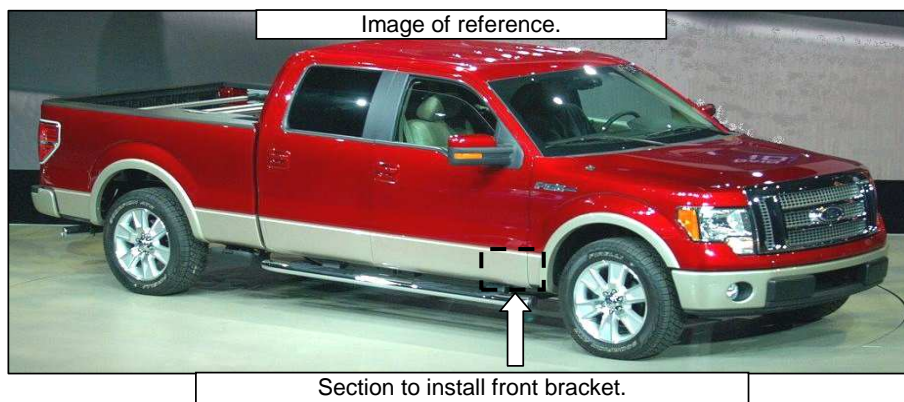

PICTURE 2

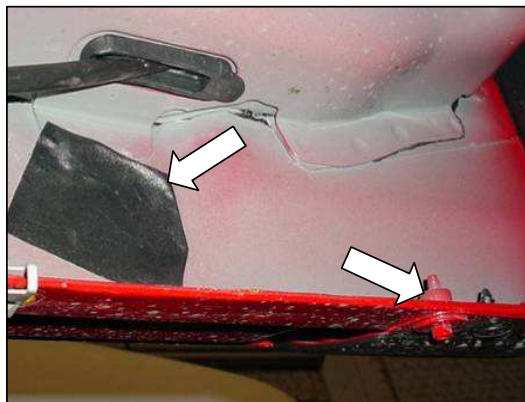

Remove this cover hole tape and bolt & clip nut. Front driver's side shown.

PICTURE 3



Insert into the square hole 5/16" bolt plate. Front driver's side shown.

4. To install rear mounting bracket, locate and remove at the rocker panel the cover tape and insert into the largest round hole (1) 1/2" bolt plate and place into the small round hole (1) 1/2 x 2" hex head bolt. **See picture 4 & 5.**
 - a).- Install the rear mounting bracket using corresponding hardware. Leave loose. **See illustration 2.**

Cleaning and care instructions:

Design :

Quality:

Keep your product clean. Do not use abrasive cleaners or polish. We recommend only non-abrasive automotive wax such as pure carnauba to avoid scratches or rust.

INSTALLATIONS INSTRUCTIONS 61248 SIDE BAR WHEEL TO WHEEL

PICTURE 4

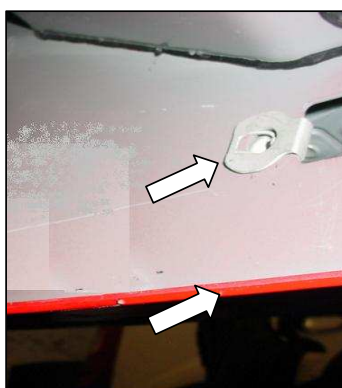
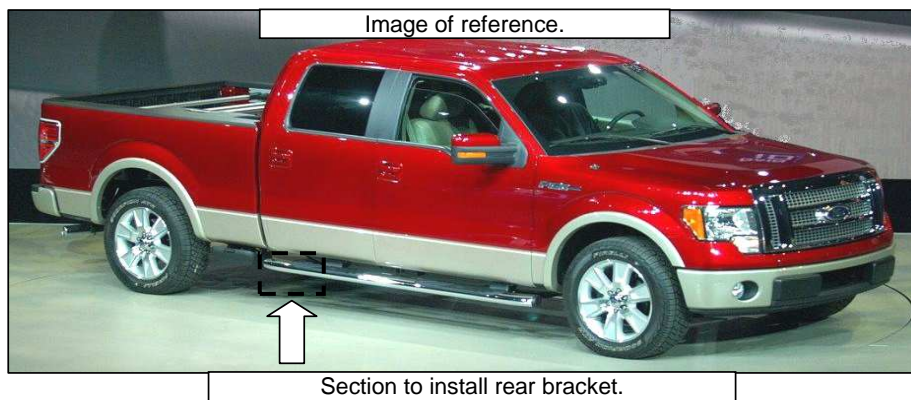

PICTURE 5

Driver side shown rear position.
3/8" clip nut installed.

5. To install Side Bar:

a).- Place side bar to the front mounting brackets and secure using (1) 1/2 x 2" hex head bolt, and (1) 1/2" flat and lock washers.

NOTE: Using same 1/2" bolt at front secure main mounting bracket and auxiliary mounting bracket.

b).- Place side bar to the rear mounting brackets and secure using: (2) 3/8 x 1 1/4" hex head bolt, (2) 3/8" flat and lock washer. Leave loose. **See Illustration 2.**

6. Align the sidebar to the vehicle and tighten all hardware. It repeats all the steps to install the opposite side.

7. Fill out the warranty card included and place it inside your vehicle.

PICTURE 6

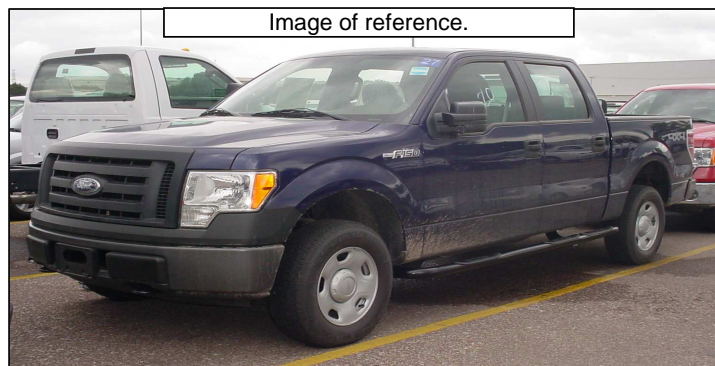

SIDE BAR INSTALLED.

Cleaning and care instructions:

Design :

Quality:

Keep your product clean. Do not use abrasive cleaners or polish. We recommend only non-abrasive automotive wax such as pure carnauba to avoid scratches or rust.