

## INSTALLATION INSTRUCTIONS

RB10 SIDE STEPS PART # 63404787

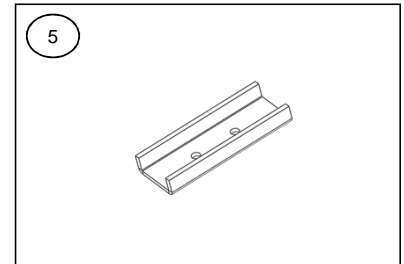
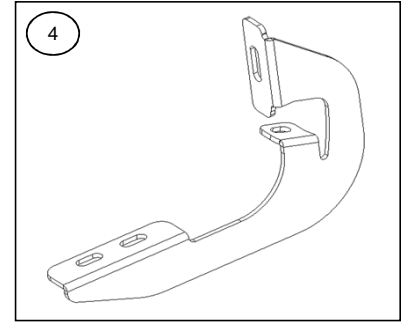
RB20 SIDE STEPS PART # 69404787

### CHEVROLET SILVERADO & GMC SIERRA CREW CAB

**Do not attempt to install this product on any vehicle other than the one listed above!**

#### PARTS LIST

ITEM	QTY.	PART #	DESCRIPTION	TORQUE
1	1		Side Steps driver & passenger	-
1	1		Side Steps driver & passenger	-
2	1		Hardware brackets kit	-
3	8	6340474AA	Bracket	-
4	8	6300874AA/4BA	U bracket	-
5	1	KTE-634047B	Hardware kit	-
6	16	-	5/16 x 1" Hex head bolt black plated	11 Lb.ft
7	16	-	5/16" Flat washer black plated	-
8	16	-	5/16" Lock washer black plated	-
9	8	-	M8 Hex nut zinc plated	20 Lb.ft
10	16	-	M8 x 25mm Hex head bolt zinc plated	20 Lb.ft
11	8	-	M8 Clip nut zinc plated	20 Lb.ft
12	24	-	5/16" Flat washer zinc plated	-
13	16	-	5/16" Lock washer zinc plated	-



#### ASSEMBLY & INSTALLATION TOOLS REQUIRED:

1/2" Socket & 1/2" Wrench  
 13mm Socket & 13mm Wrench  
 Ratchet  
 Extension.

**Approximate installation time: 40 min.**

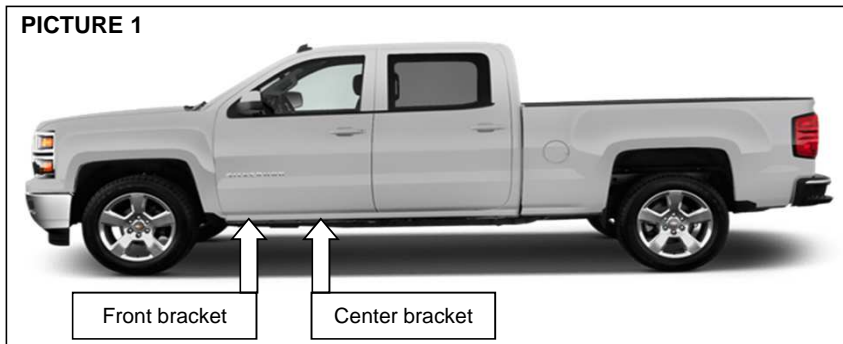
Read the assembly and installation instructions completely and verify that all of the parts listed are accounted for. If you have defective, missing or damaged parts or need assistance, please contact Go Rhino Products for fast, friendly customer service at: 1-888-427-4466 or email: [warranty@gorhino.com](mailto:warranty@gorhino.com)

It is the customer's responsibility to protect the finish with a regular application of a nonabrasive polish compatible with the products finish. **NOTE: LOOK THE POSITION BEFORE INSTALLING THE BRACKETS.**

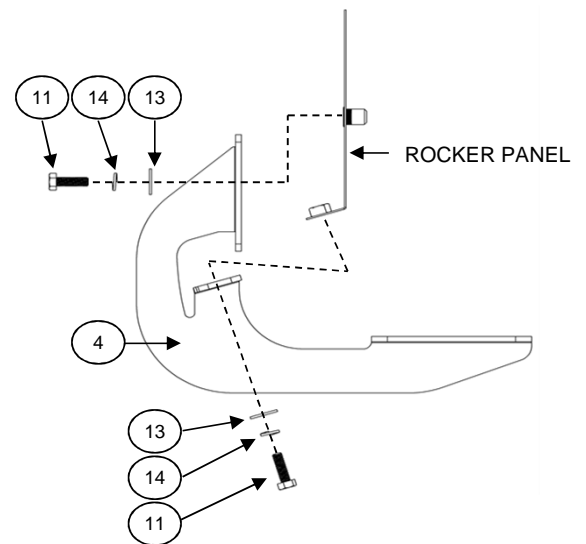
#### INSTALLATION

**Step-1** Locate in the front and center in rocker panel of the vehicle the existing nut threaded hole. **SEE PICTURE 1 & 2.** Place the bracket and attach with: M8 hex head bolt, M8 flat and lock washers (zinc plated), according to the **ILLUSTRATION 1.** Leave loose. Repeat for the opposite side.

**PICTURE 1**

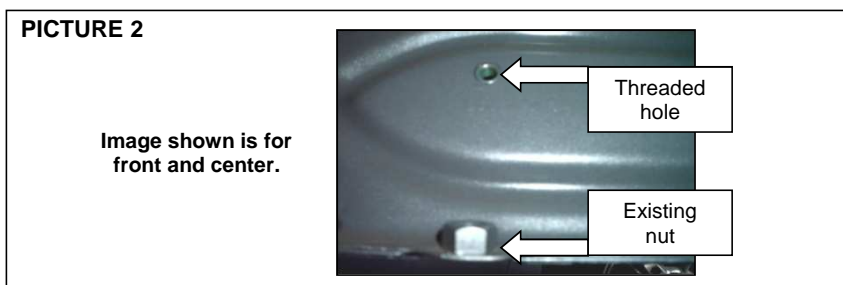


**ILLUSTRATION 1**

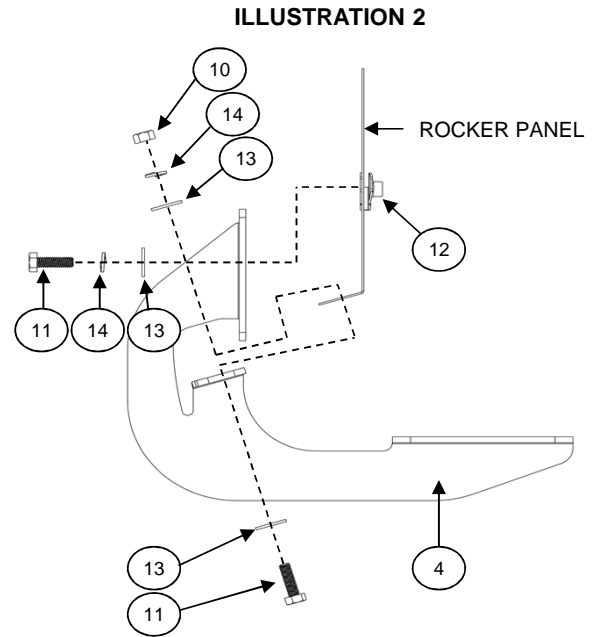
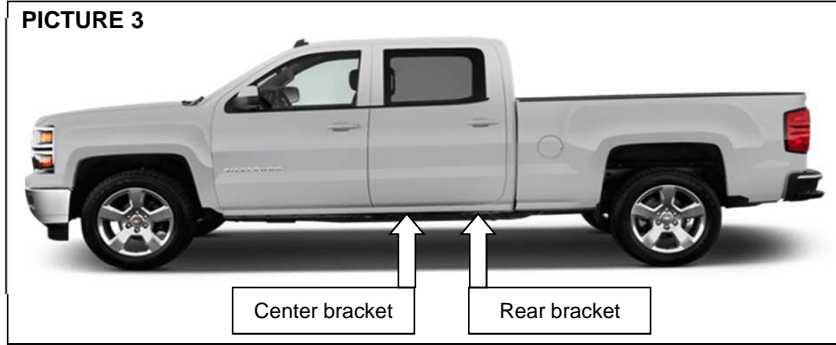


Use wrench, ratchet, hex socket 13mm.

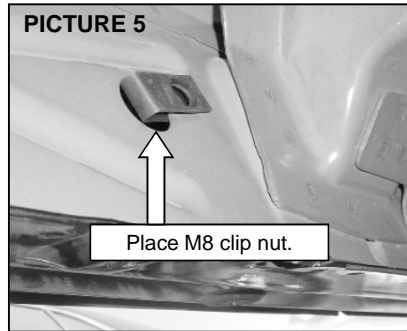
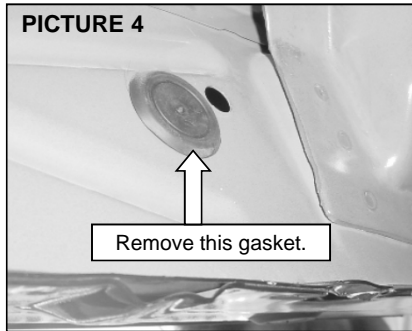
**PICTURE 2**



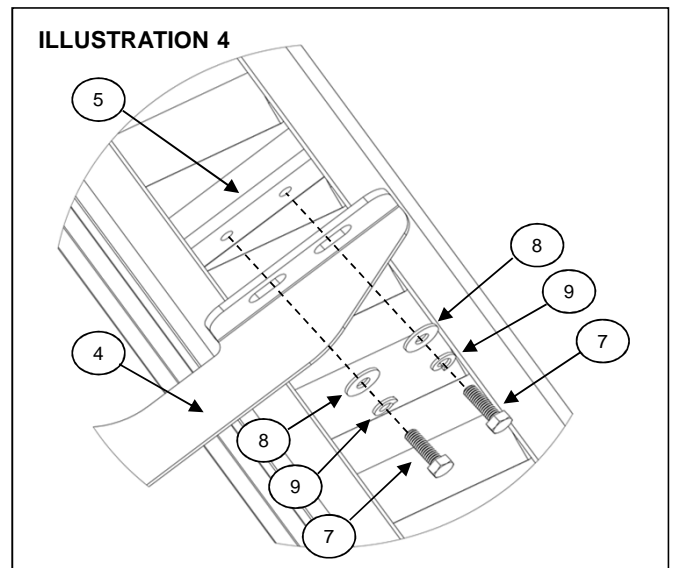
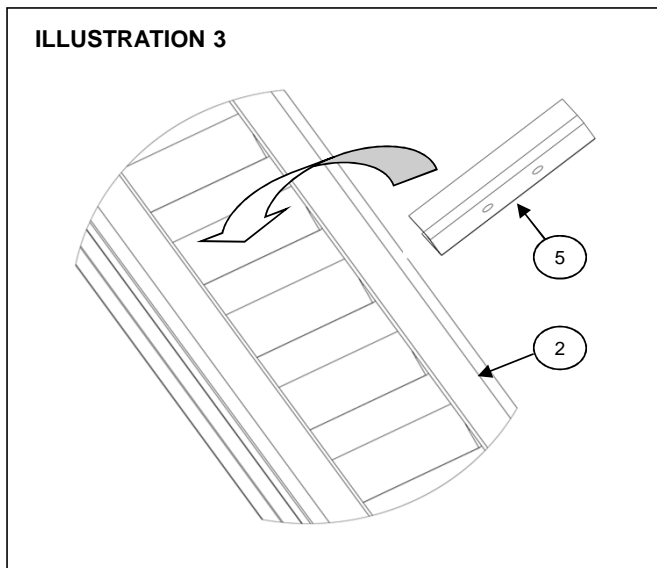
**Step-2** Locate in the center and rear in the rocker panel of the vehicle the hole and insert a M8 clip nut. **SEE PICTURE 3 & 4 & 5.** Place the bracket and attach with: M8 hex head bolt, M8 flat and lock washers, M8 hex nut (zinc plated), according to the **ILLUSTRATION 2.** Leave loose. Repeat for the opposite side.



Use wrench, ratchet, hex socket 13mm.



**Step-3** Place the U bracket and attach with: 5/16" hex head bolt, 5/16" Flat and lock washer (black plated), by each bracket. **SEE ILLUSTRATION 3 & 4.** Repeat for the opposite side. Leave loose.



Use ratchet & 1/2" hex socket.

**Step-4** Align the side bar and then tighten all bolts.

**Step-5** Periodically check your product because it may need a re-tighten of bolts.

**Step-6** Fill the warranty card and place it inside your vehicle's glove box.