



# TYPHOON INTAKE SYSTEMS

INTAKE SYSTEMS FOR VEHICLES LISTED ARE 50 STATE LEGAL. SEE KNFILTERS.COM FOR CARB STATUS ON EACH PART FOR A SPECIFIC VEHICLE.

## INSTALLATION INSTRUCTIONS

**69-3528TS**  
**FORD**  
**2010-12 Taurus**  
**V6-3.5L**

**TOOLS NEEDED:**

- Ratchet
- Extension
- 8mm Socket
- T15 Torx
- 4mm Allen
- 3mm Allen
- Flat Blade Screwdriver
- 9/16" Wrench
- 13mm Wrench
- 10mm Wrench
- Pliers.

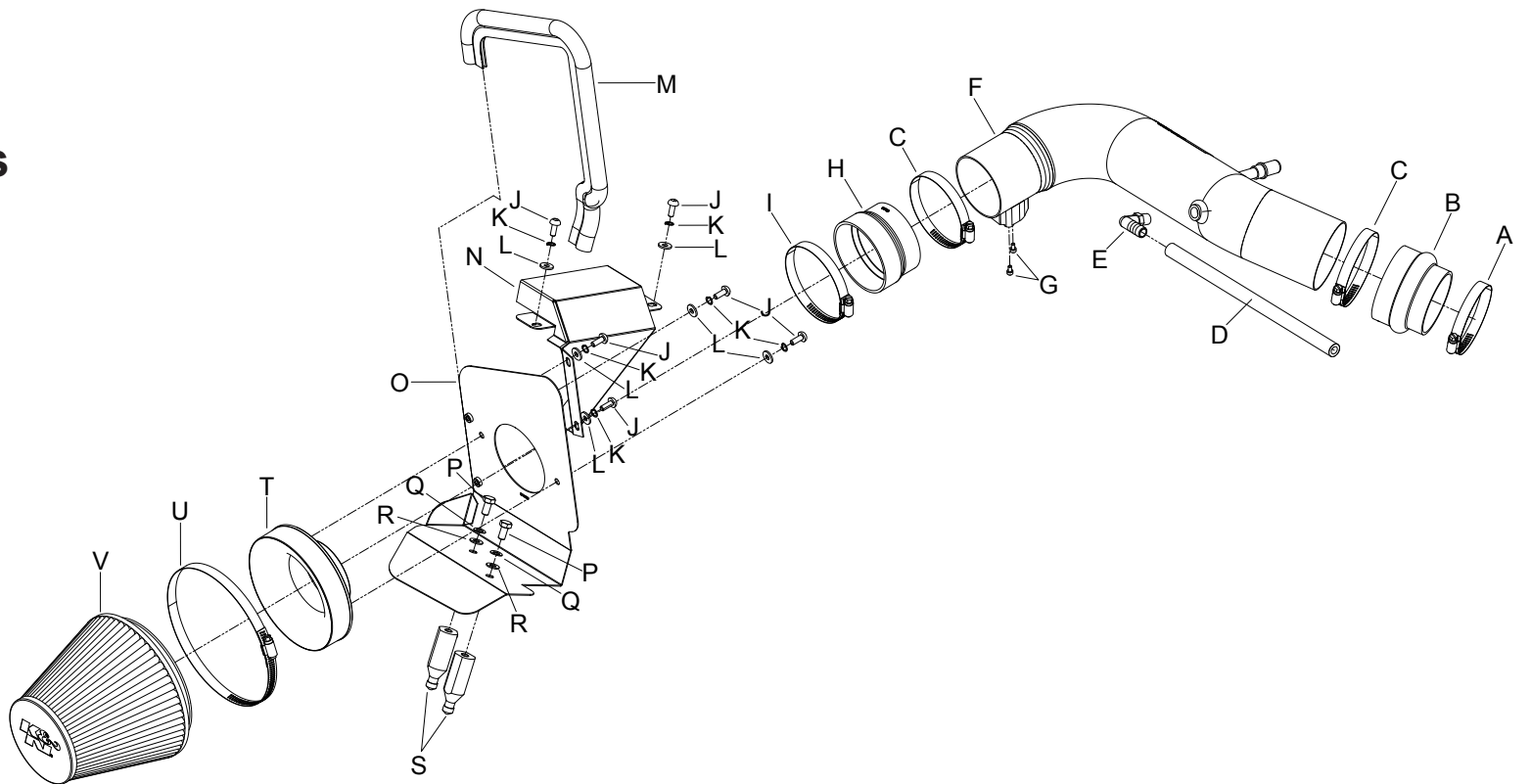

**PARTS LIST:**

Description	Qty.	Part #	Description	Qty.	Part #
A Hose Clamp #48	1	08601	L Washer; 1/4"ID X 5/8"OD - SAE	6	08275
B Hose; 3-1/2" TO 3" ID X 2-1/2" L Hump	1	084079	M Edge Trim (23")	1	102495
C Hose Clamp #52	2	08610	N Heat Shield (Scoop)	1	074083
D Hose; 3/8" ID X 12" L	1	08412	O Heat Shield	1	074082
E Vent; 90°, 1/2"Hose, 1/4"NPT, Blk., Plastic	1	08110FK	P Bolt; 8MM-1.25 X 16MM, Hexhead	2	07844
F Intake Tube	1	27476	Q Washer; 8MM Spring (Wave)	2	08239
G Bolt; M4 - 0.07 8MM, A/H Cap, SS	2	07733	R Washer; 5/16"ID X 5/8"OD, Flat	2	08276
H 3.25"ID TO 3.50"ID X 2.25"L, Tprd., Blk.	1	084091	S Standoff	2	06532
I Hose Clamp #56	1	08620	T Adapter; Universal, 6" Filter 3.5" Coupler	1	21512-1
J Bolt; M6 X 1.00 X 16MM , Buttonhead, SS	6	07730	U Hose Clamp #104	1	08697
K Washer; 1/4" Lock, ZN	6	08198	V Air Filter	1	RF-1048

**NOTE: FAILURE TO FOLLOW INSTALLATION INSTRUCTIONS AND NOT USING THE PROVIDED HARDWARE MAY DAMAGE THE INTAKE TUBE, THROTTLE BODY AND ENGINE.**

**TO START:**

1. Turn off the ignition and disconnect the negative battery cable.  
**NOTE: Disconnecting the negative battery cable erases pre-programmed electronic memories. Write down all memory settings before disconnecting the negative battery cable. Some radios will require an anti-theft code to be entered after the battery is reconnected. The anti-theft code is typically supplied with your owner's manual. In the event your vehicles' anti-theft code cannot be recovered, contact an authorized dealership to obtain your vehicles anti-theft code.**

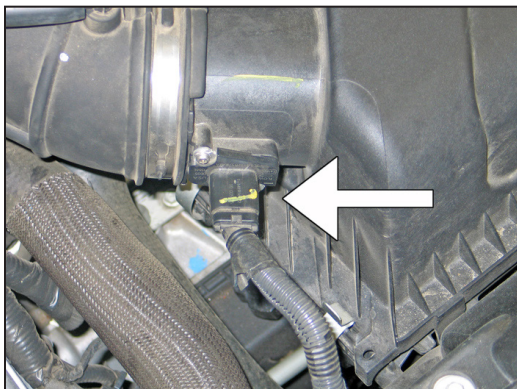

2. Release the red locking tab and then disconnect the mass air sensor electrical connection.



3. Disconnect the EVAP hose from the check valve connection.

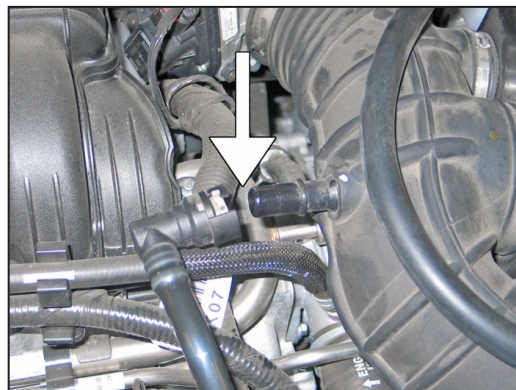

4. Release the grey locking tab and then disconnect the crankcase vent line from the intake tube.

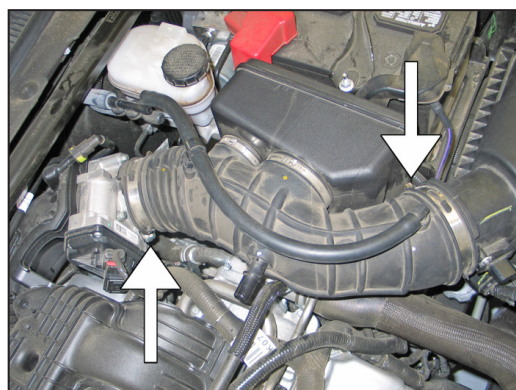

5. Loosen the two hose clamps that secure the stock intake tube to the throttle body and air filter housing.



6. Remove the stock intake tube from the vehicle.

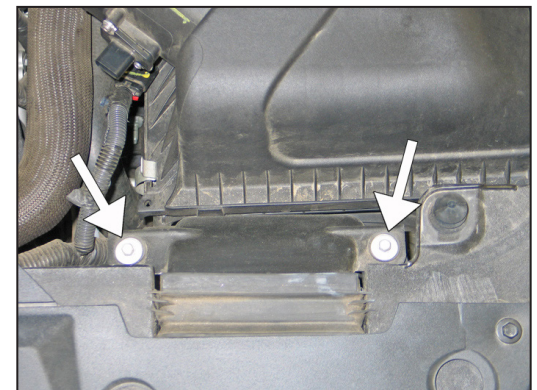

7. Remove the two bolts shown that secure the fresh air duct to the core support.

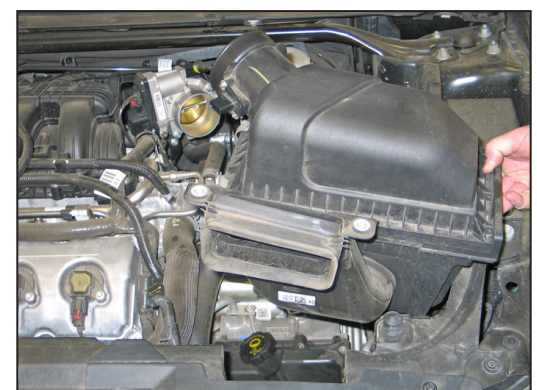

8. Lift up the airbox assembly to dislodge it from the mounting grommets and then remove the airbox from the vehicle.  
**NOTE: K&N Engineering, Inc., recommends that customers do not discard factory air intake.**



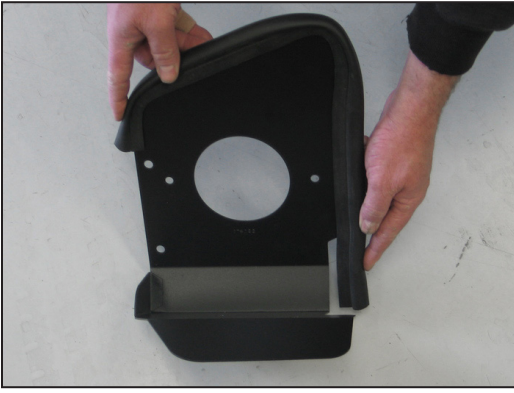

9. Install the provided edge trim onto the heat shield as shown.

**NOTE: Trimming of the edge trim will be necessary.**

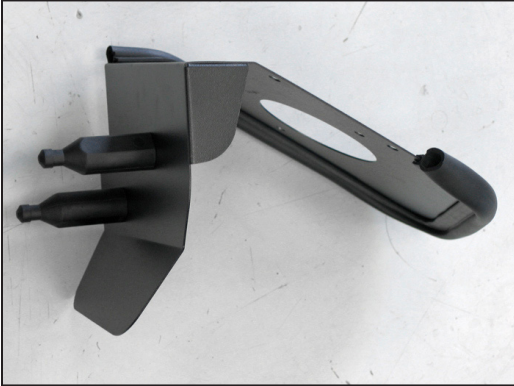

10. Install the heat shield mounts onto the heat shield and secure with the provided hardware.

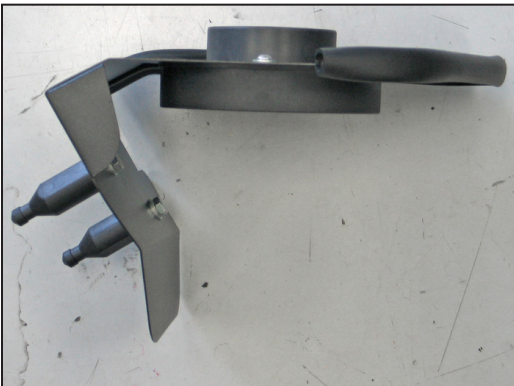

11. Install the filter adapter onto the heat shield and secure with the provided hardware.



12. Install the K&N® air filter onto the filter adapter and secure with the provided hose clamp.

**NOTE: Drycharger® air filter wrap; part # RF-1048DK is available to purchase separately. To learn more about Drycharger® filter wraps or look up color availability please visit <http://www.knfilters.com>®.**



13. Install the heat shield/filter assembly into the vehicle so that the mounts snap into the factory airbox mounts.

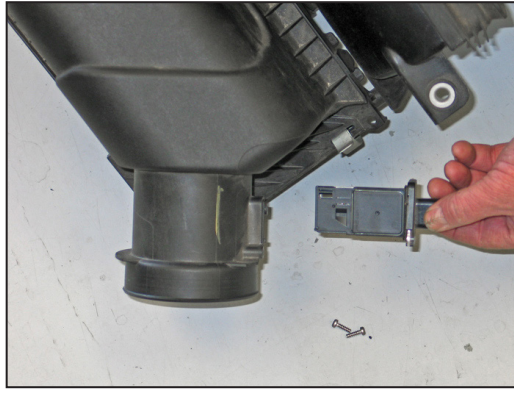

14. Remove the mass air sensor mounting bolts, then remove the mass air sensor from the factory airbox.

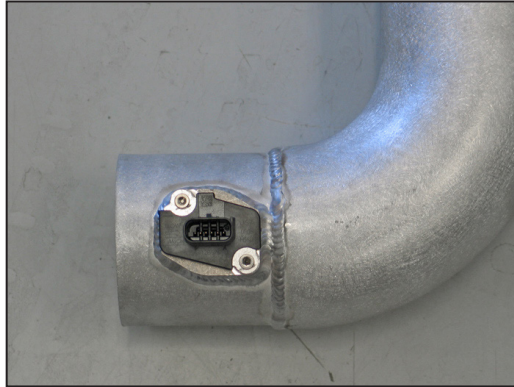

15. Install the mass air sensor into the K&N® intake tube and secure with the provided hardware.



16. Install the provided 90° npt vent fitting into the K&N® intake tube as shown.

**NOTE: Plastic NPT fittings are easy to cross thread. Install the vent fitting "hand" tight, then turn it two complete turns with a wrench.**



17. Install the provided silicone hose (084079) onto the throttle body and secure with the provided hose clamp.



18. Install the provided silicone hose (084091) onto the K&N® intake tube as shown and secure with the provided hose clamp.



19. Install the K&N® intake tube assembly into the hose at the throttle body and then onto the filter adapter and secure with the provided hose clamp.

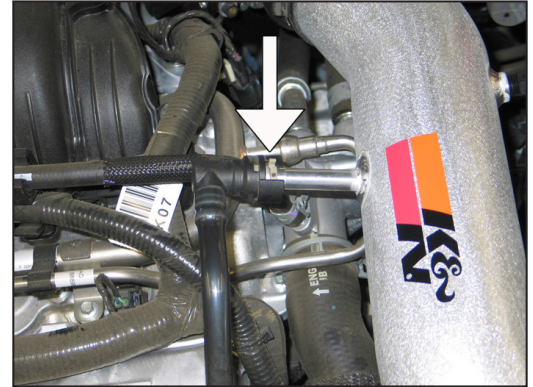

20. Connect the crankcase vent hose to the quick connect fitting on the K&N® intake tube.

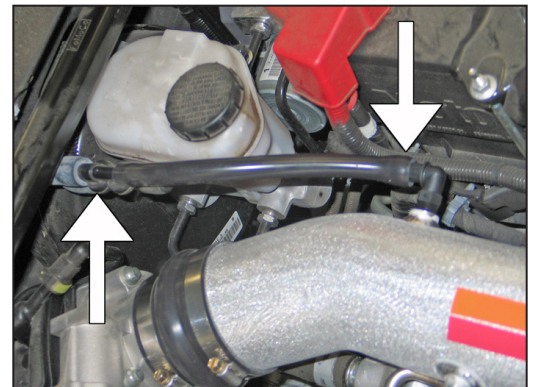

21. Connect the provided EVAP hose onto the 90° vent fitting installed in the K&N® intake tube, then connect the open end to the EVAP check valve as shown.



22. Reconnect the mass air sensor electrical connection.



23. Install the fresh air intake scoop into position and secure to the heat shield and core support with the provided hardware.





24. Reconnect the vehicle's negative battery cable. Double check to make sure everything is tight and properly positioned before starting the vehicle.

22. The C.A.R.B. exemption sticker, (attached), must be visible under the hood so that an emissions inspector can see it when the vehicle is required to be tested for emissions. California requires testing every two years, other states may vary.

26. It will be necessary for all K&N® high flow intake systems to be checked periodically for realignment, clearance and tightening of all connections. Failure to follow the above instructions or proper maintenance may void warranty.

#### ROAD TESTING:

1. Start the engine with the transmission in neutral or park, and the parking brake engaged. Listen for air leaks or odd noises. For air leaks secure hoses and connections. For odd noises, find cause and repair before proceeding. This kit will function identically to the factory system except for being louder and much more responsive.

2. Test drive the vehicle. Listen for odd noises or rattles and fix as necessary.

3. If road test is fine, you can now enjoy the added power and performance from your kit.

4. K&N Engineering, Inc., requires cleaning the intake system's air filter element every 100,000 miles. When used in dusty or off-road environments, our filters will require cleaning more often. We recommend that you visually inspect your filter once every 25,000 miles to determine if the screen is still visible. When the screen is no longer visible some place on the filter element, it is time to clean it. To clean and re-oil, purchase our filter Recharger® service kit, part number 99-5050 or 99-5000 and follow the easy instructions.

**INTAKE SYSTEMS FOR VEHICLES LISTED ARE 50 STATE LEGAL. SEE KNFILTERS.COM FOR CARB STATUS ON EACH PART FOR A SPECIFIC VEHICLE.**

\* FREE K&N® decal To register your warranty, please see us online at [knfilters.com/register](http://knfilters.com/register). FREE K&N® decal \*