



AUTOMOTIVE PRODUCTS,

# INSTALLATION INSTRUCTIONS

## HDX GRILLE GUARD

### APPLICATION:

2016-2017 Nissan Titan XD

### PART NUMBER:

57-3915

ITEM	QUANTITY	DESCRIPTION	TOOLS NEEDED
1	1	GRILLE GUARD ASSEMBLY	10MM SOCKET
2,3	2	UPPER SUPPORT STRAP, DRIVER (2) AND PASSENGER (3)	10MM WRENCH
4,5	2	LOWER MOUNT BRACKET, DRIVER (4) AND PASSENGER (5)	13MM SOCKET
6	4	SHORT SPACER (YELLOW)	RATCHET
7	2	TALL SPACER (BLACK)	TORQUE WRENCH
8	4	M12 HEX HEAD CAP SCREW (YELLOW ZINC)	18MM WRENCH
9	4	M12 FLAT WASHER (YELLOW ZINC)	18MM SOCKET
10	4	M12 SPLIT LOCK WASHER (YELLOW ZINC)	19MM WRENCH
11	2	M10 HEX HEAD FLANGE BOLT (YELLOW ZINC)	19MM WOCKET
12	4	M12 HEX SOCKET BUTTON HEAD SCREW (BLACK ZINC)	15MM WRENCH
13	4	M12 BELLEVILLE WASHER (BLACK ZINC)	15MM SOCKET
14	4	M12 HEX SERRATED FLANGE NUT (BLACK ZINC)	16MM WRENCH
15	2	M10 HEX SOCKET BUTTON HEAD SCREW (BLACK ZINC)	16MM SOCKET
16	2	M10 BELLEVILLE WASHER (BLACK ZINC)	
17	2	M10 HEX HEAD SERRATED FLANGE NUT (BLACK ZINC)	

**ANTI-SEIZE LUBRICANT MUST BE USED ON ALL STAINLESS STEEL FASTENERS TO PREVENT THREAD DAMAGE AND GALLING**

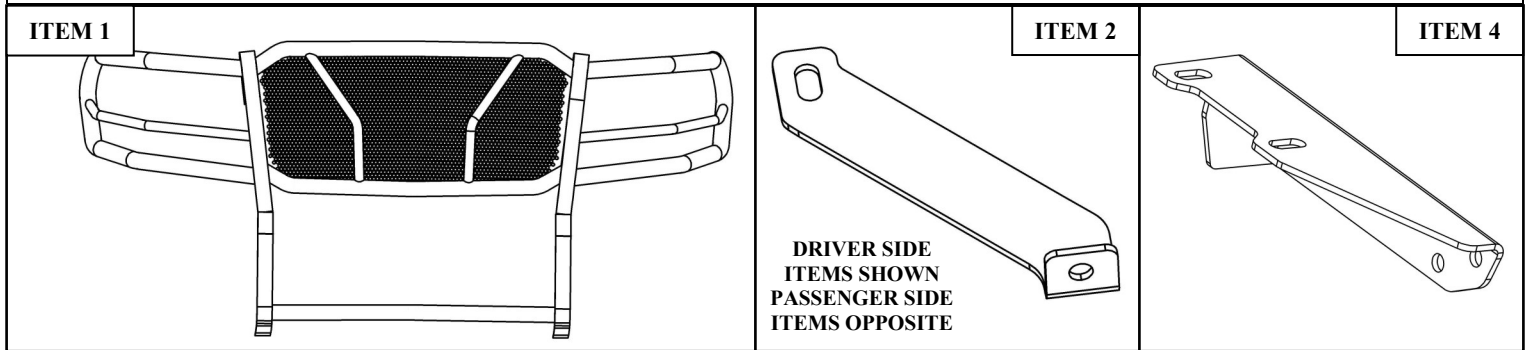

### PROCEDURE

1. Remove contents from box, verify if all parts listed are present and free from damage.  
Carefully read and understand all instructions before attempting installation.  
**Failure to identify damage before installation could lead to a rejection of any claim.**



Westin Automotive Products, Inc.  
320 W. Covina Blvd  
San Dimas, Ca. 91773

Thank you for choosing Westin products  
for additional installation assistance please call  
Customer Service (800) 793-7846

2. Remove the vehicles grille. Start by removing clips located on top of the grille under the hood and on the both sides of the front face of the grille. Refer to **Figures 1 and 2**.

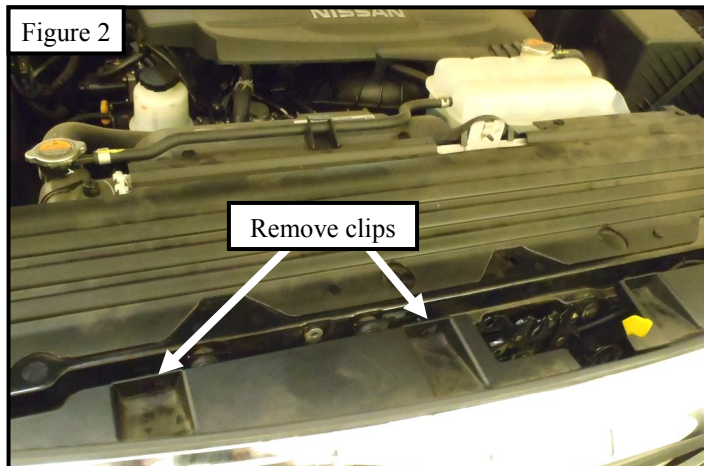
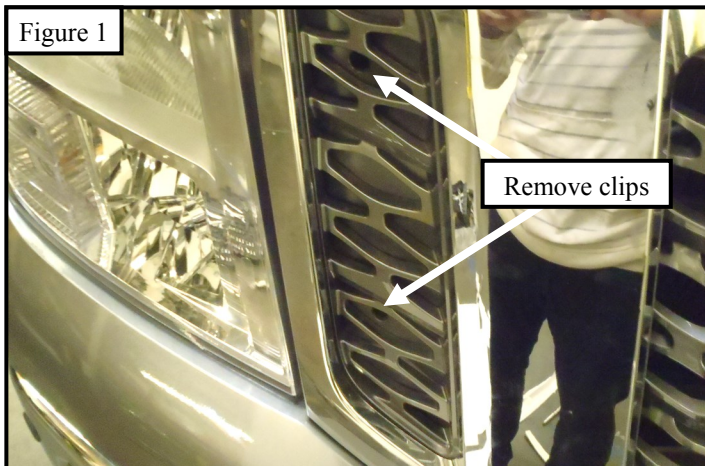

3. Carefully pull off the grille by unclipping the plastic clips. See **Figure 3**.
4. Locate screws near the rear tire and plastic clips on mud guard, and remove them in order to remove the mud guard. Repeat for other side. See **Figure 4**.

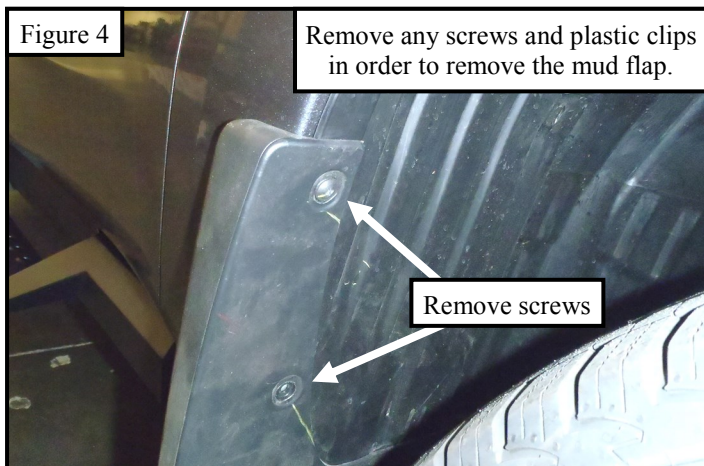
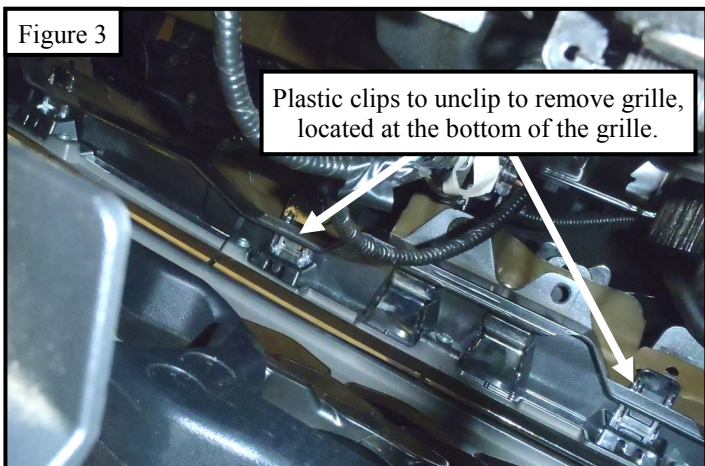

5. Find screw hidden underneath mud guard and remove. See **Figure 5**. Then remove filler panel see **Figure 6**.

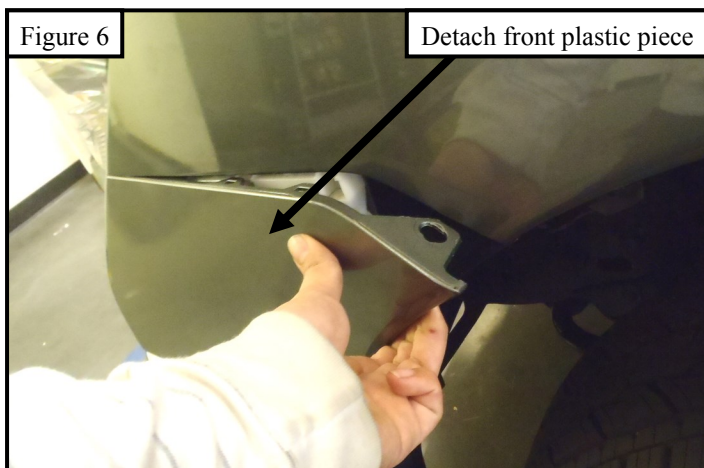
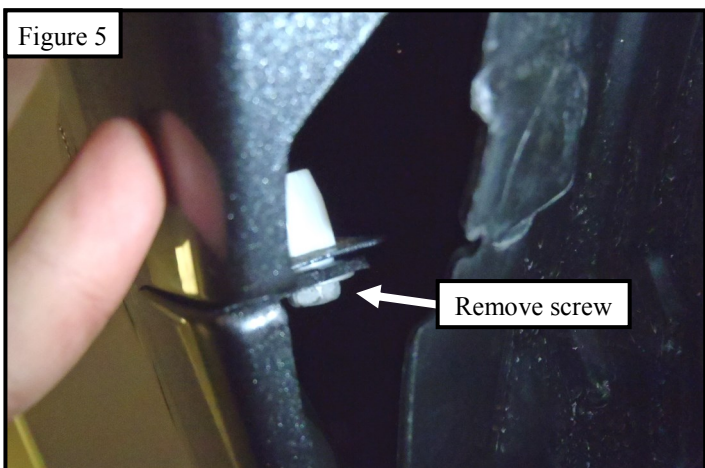

6. Unclip wire clips that attach to brackets as shown in **Figures 7 and 8**. Remove bolts to remove filler panel bracket.

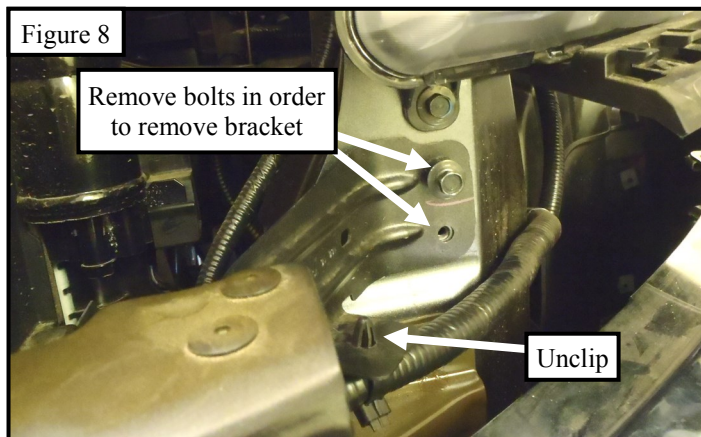
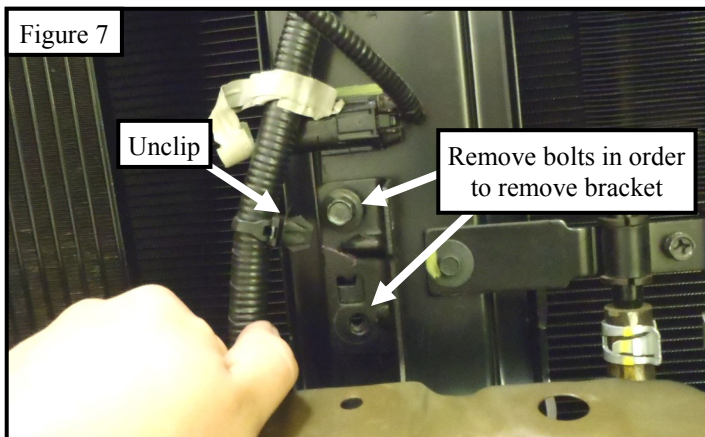

7. On top of the bumper locate torque screw and remove with a T-45 bit. See **Figure 9**.

8. Locate (1) upper support strap (Item 2/3) and loosely attach onto location where factory screw was previously removed using the provided short yellow zinc spacer (Item 7) and M10 hex head flange bolt (Item 11). See **Figure 10**.

9. Repeat **Step 8** for other vehicle side.

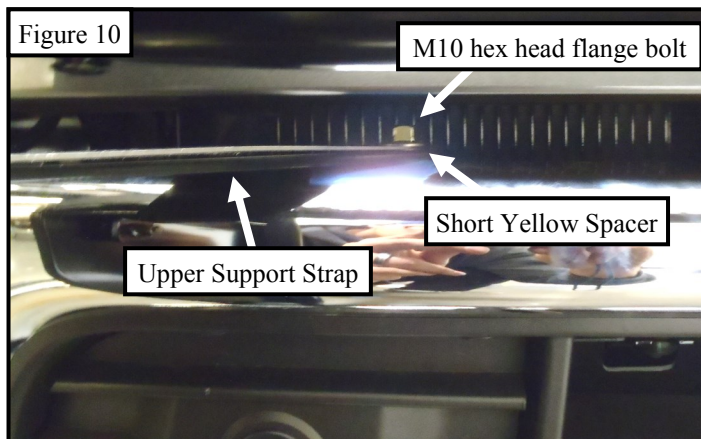
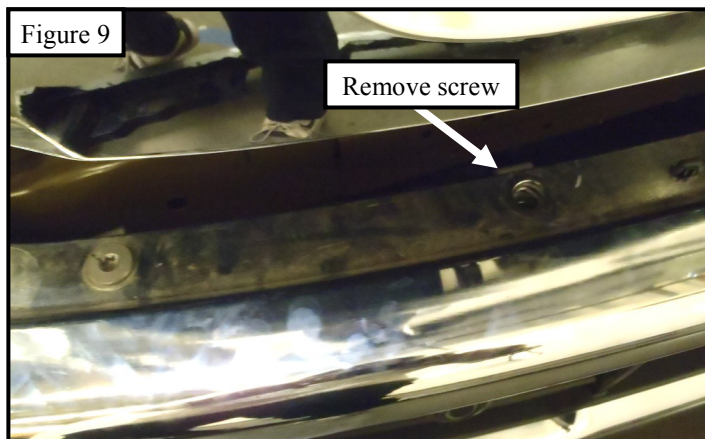

10. Reinstall the everything that was removed.

11. Remove factory tow hooks if present. **Note:** Factory tow hooks will not be reused.

12. Trim the valance guard as necessary in order to loosely secure the lower mount bracket (Item 4/5) onto the vehicle frame using the provided M12 hardware (Items 8-10), (1) tall black spacer and (1) short yellow spacer. See **Figures 11 and 12**.

13. Repeat **Step 12** for other vehicle side.

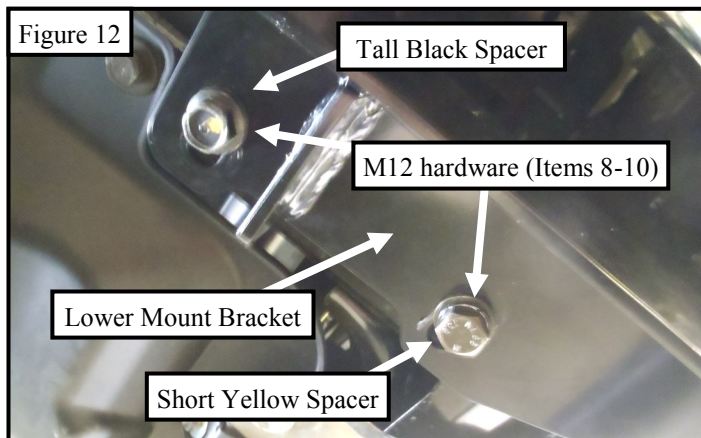
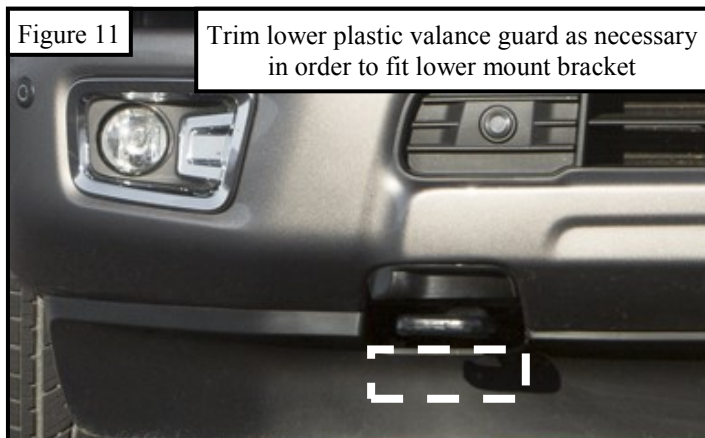

Westin Automotive Products, Inc.  
320 W. Covina Blvd  
San Dimas, Ca. 91773

14. Locate the grille guard assembly (Item 1) and with assistance carefully align onto previously installed support strap and mount bracket and loosely install using the provided M10 and M12 black zinc hardware (Items 12-17). See **Figure 13**.
15. Align and adjust grille guard assembly, upper support strap, and lower mount bracket as necessary and then torque all fasteners: M10 to 30 - 35 ft-lbs and M12 to 50 - 55 ft-lbs.

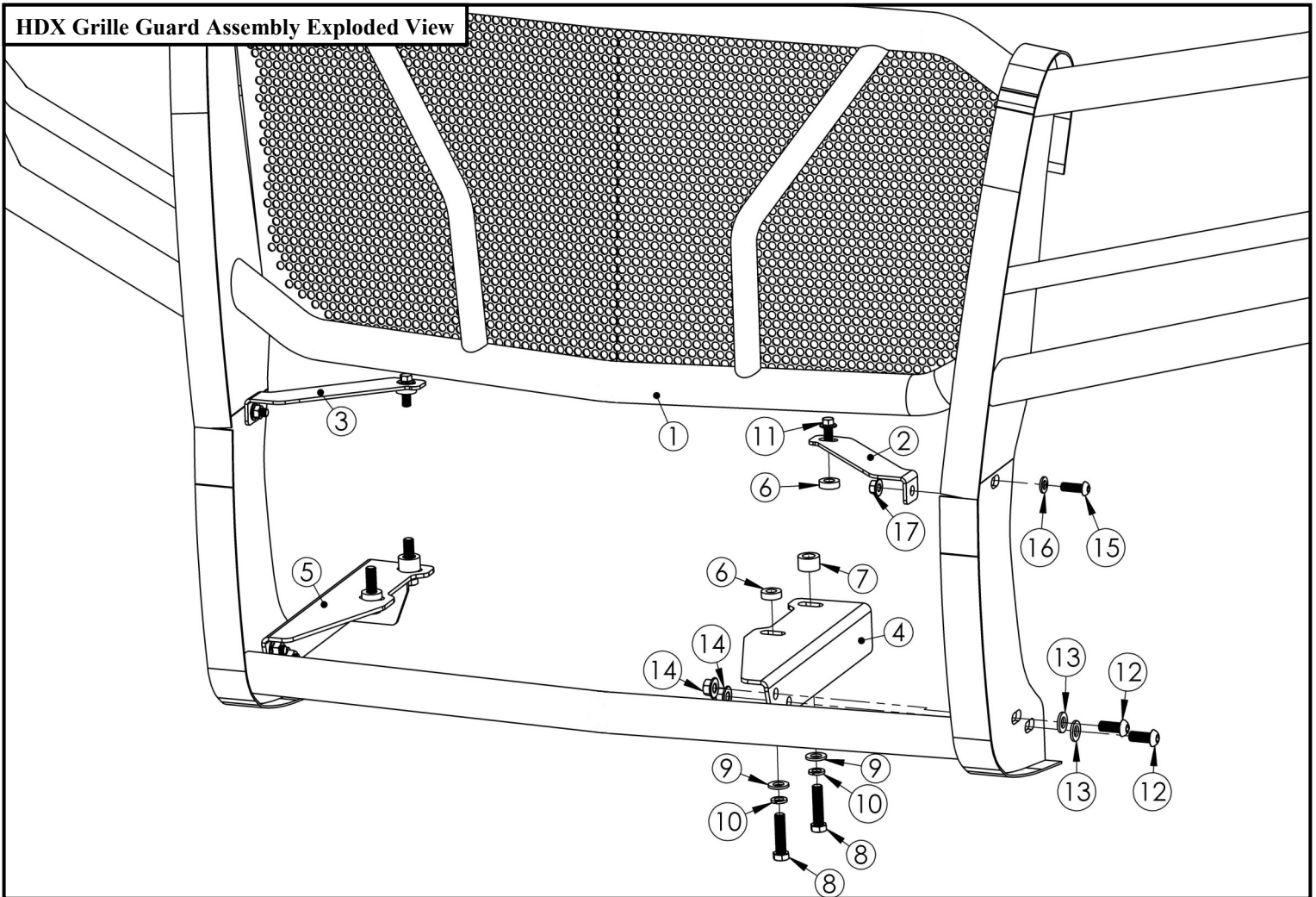
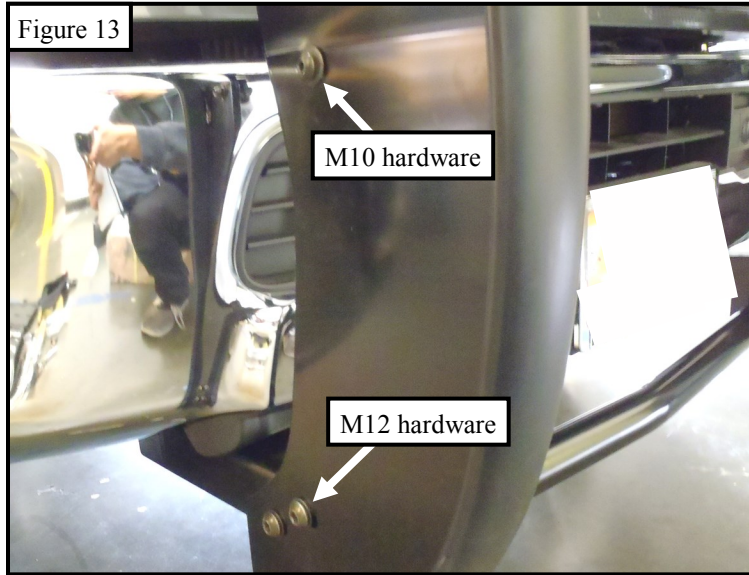

Westin Automotive Products, Inc.  
320 W. Covina Blvd  
San Dimas, Ca. 91773

Thank you for choosing Westin products  
for additional installation assistance please call  
Customer Service (800) 793-7846

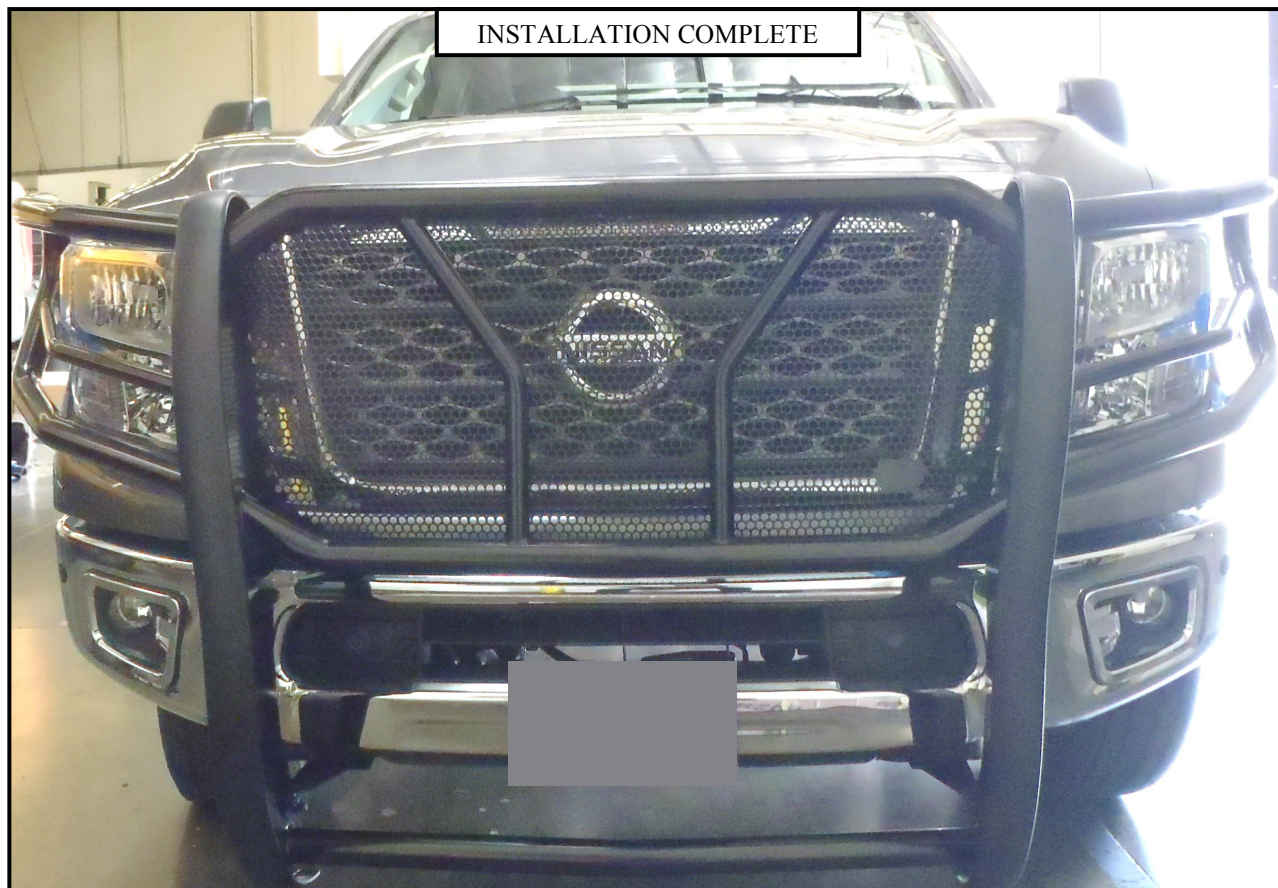

#### CARE INSTRUCTIONS

- REGULAR WAXING IS RECOMMENDED. DO NOT USE ANY TYPE OF POLISH OR WAX THAT MAY CONTAIN ABRASIVES.
- STAINLESS STEEL PRODUCTS CAN BE CLEANED WITH MILD SOAP AND WATER. STAINLESS STEEL POLISH SHOULD BE USED TO POLISH SMALL SCRATCHES.
- GLOSS BLACK FINISHES SHOULD BE CLEANED WITH MILD SOAP AND WATER.



Westin Automotive Products, Inc.  
320 W. Covina Blvd  
San Dimas, Ca. 91773

Thank you for choosing Westin products  
for additional installation assistance please call  
Customer Service (800) 793-7846  
[www.westinautomotive.com](http://www.westinautomotive.com)



SIGNATURE OF QUALITY

AUTOMOTIVE PRODUCTS, INC.

# WARNINGS & NOTICES FOR THE INSTALLATION OF MAX WINCH TRAY & SPORTSMAN—WINCH MOUNTS

## NOTICE

Westin Max Winch Trays are designed to accommodate a winch bolt pattern of 10" X 4.5". Closely follow all Westin Installation Instructions for the proper installation of product. Improper installation can result in death, serious injury, and/or product and vehicle damage. In the operation of these products, it is imperative to observe precautions for your personal

### **WARNING**

Failure to follow these instructions could lead to death, personal injury, and / or property damage.

#### FASTENERS:

All Westin supplied fasteners must be utilized and installed in accordance with the installation instructions and apply torque to the specifications as defined. **DOUBLE CHECK ALL FASTENERS BEFORE PRODUCT USE TO ENSURE PROPER FUNCTION AND SAFETY.**

#### DRILLING:

Most Westin products do not require drilling for installation. If drilling is defined as required, use caution when drilling a vehicle. **FAILURE TO REVIEW AN AREA TO BE DRILLED MAY RESULT IN PERSONAL INJURY AND OR INJURY TO OTHERS AS WELL AS VEHICLE DAMAGE.**

#### EYE PROTECTION:

**ALWAYS WEAR SAFETY GLASSES OR GOGGLES DURING THE INSTALLATION PROCESS TO AVOID PERSONAL INJURY.**

#### TOW HOOKS—TOW ATTACHMENT:

During product use, Tow Straps, Tow Cables, and Tow Hooks must only be attached to the Westin Tow Hook Loops as attached to the Max Winch Tray, (sold separately). **DO NOT ATTACH TO ANY OTHER AREA OR SERIOUS PERSONAL INJURY OR INJURY TO OTHERS MAY OCCUR.**

#### WINCH SIZING & MAX WINCH TRAY CAPACITY:

The Max Winch Tray is designed for a maximum Winch size rating of 12,000 Lbs. Use of Winch size ratings above this limit will void the Westin warranty and **MAY RESULT IN PERSONAL INJURY AND OR INJURY TO OTHERS AS WELL AS VEHICLE DAMAGE.**



Westin Automotive Products, Inc.  
320 W. Covina Blvd  
San Dimas, Ca. 91773

SIGNATURE OF QUALITY