



INTAKE SYSTEMS FOR VEHICLES LISTED ARE 50 STATE LEGAL. SEE KNFILTERS.COM FOR CARB STATUS ON EACH PART FOR A SPECIFIC VEHICLE.

INSTALLATION INSTRUCTIONS

77-2552KP
FORD / MAZDA
2001-03 Ranger / B2300
L4-2.3L DOHC

NOTE: This kit was not designed to fit vehicles with a body lift.

TOOLS NEEDED:

- Flat blade screwdriver
- Ratchet
- 7mm Socket
- 8mm Socket
- 10mm Socket
- 9/16" Socket

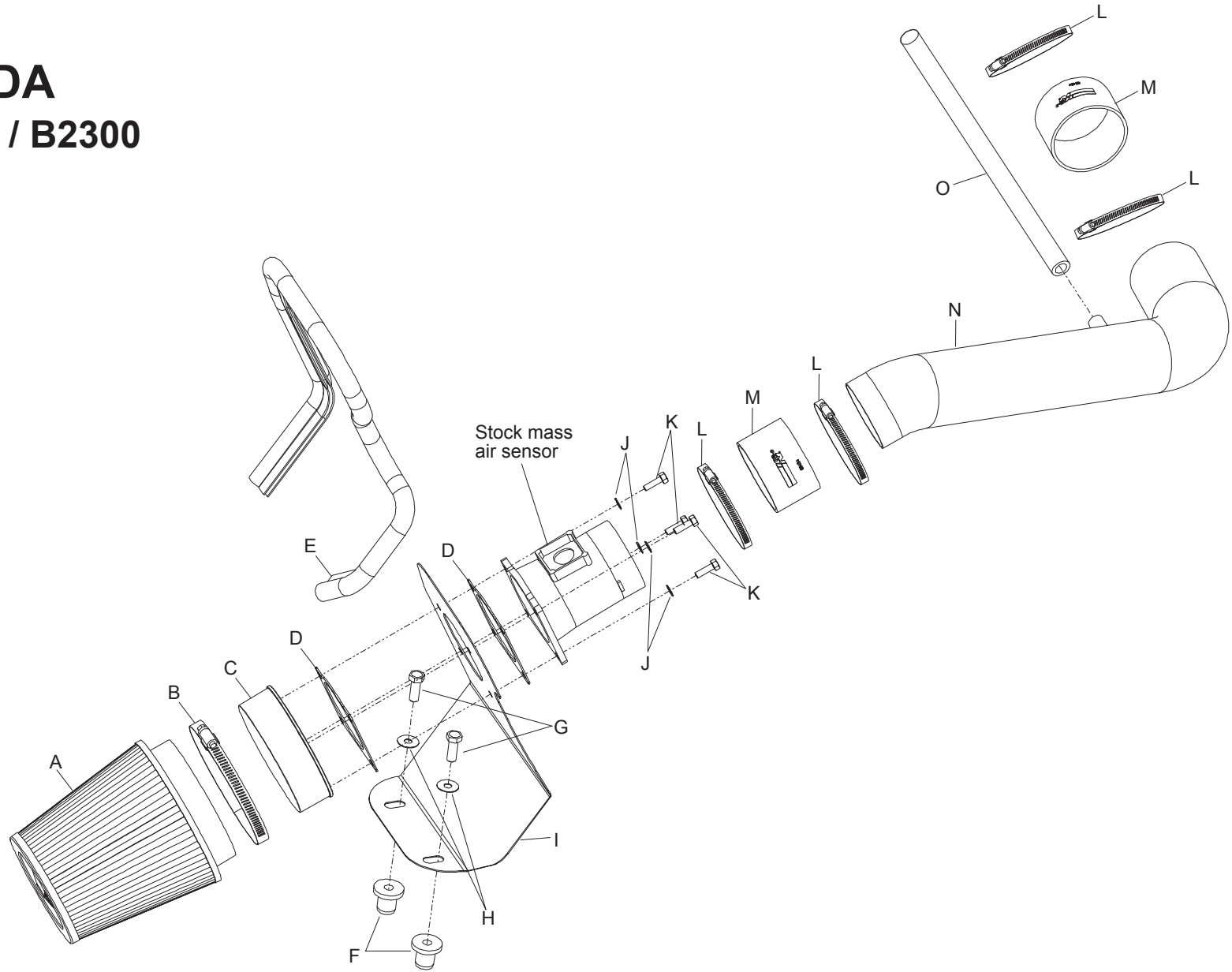

PARTS LIST:

Description	Qty.	Part #	Description	Qty.	Part #	Description	Qty.	Part #
A Air Filter	1	RF-1037	F Nut, Expansion	2	08163	K Bolt, M6-1.00 x 20mm L, Hex	4	07795
B Hose Clamp, #80	1	08694	G Bolt, 3/8-16 x 1-1/4" Hex	2	07779	L Hose Clamp, #48	4	08601
C Adapter, Mass Air	1	21510	H Washer, 3/8" Flat	2	08134	M Hose, 3"ID x 2"L, Silicone	2	08434
D Gasket, 1/16" Neoprene	2	09202	I Heat Shield, FB/PC	1	07308	N Intake Tube	1	27142
E Edge Trim, 3/4" Bulb, 39" L.	1	102496	J Washer, 6mm Flat	4	08269	O Hose, 1/2" ID x 14"L, Silicone	1	08402

NOTE: FAILURE TO FOLLOW INSTALLATION INSTRUCTIONS AND NOT USING THE PROVIDED HARDWARE MAY DAMAGE THE INTAKE TUBE, THROTTLE BODY AND ENGINE.

TO START:

1. Turn off the ignition and disconnect the negative battery cable. **NOTE: Disconnecting the negative battery cable erases pre-programmed electronic memories. Write down all memory settings before disconnecting the negative battery cable. Some radios will require an anti-theft code to be entered after the battery is reconnected. The anti-theft code is typically supplied with your owner's manual. In the event your vehicles' anti-theft code cannot be recovered, contact an authorized dealership to obtain your vehicles anti-theft code.**



2. Disconnect the mass air sensor electrical connection as shown.

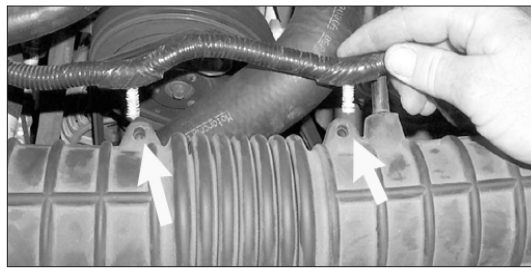

3. Unclip the wire harness from the stock intake tube as shown.

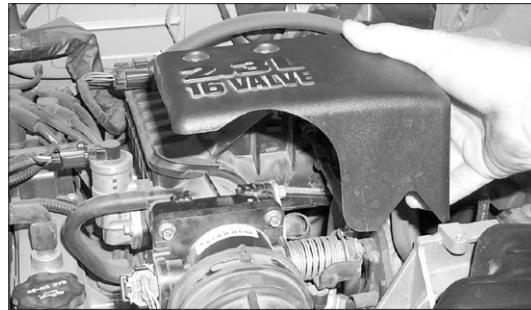

4. Remove the throttle body cover which is secured by two bolts as shown.



5. On vehicles with and intake resonator remove the bolt that secures the resonator to the engine bracket as shown.

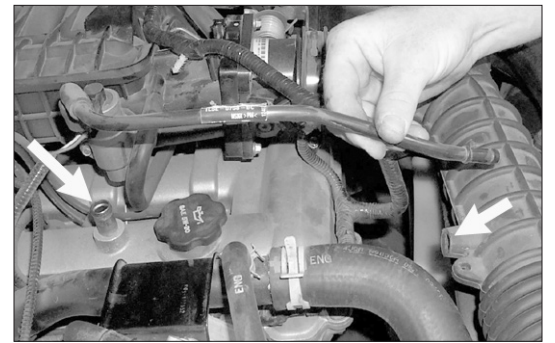

6. Remove the crank case vent hose from the vent on the cam cover and remove the other end from the vent on the stock intake tube as shown.

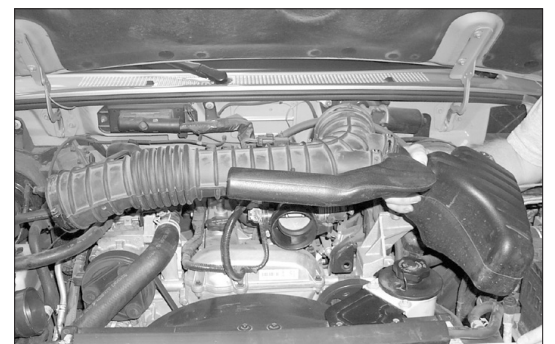

7. Loosen the hose clamps at the throttle body and at the mass air sensor, then, remove the stock intake tube as shown.



8. Rotate the air condition hard line and the coolant overflow line upward as shown.



9. Unclip the air cleaner cover and remove as shown.



10. Using a flat blade screwdriver insert the blade between the air cleaner tray and the bottom of the lower air cleaner. Pry downward on the tray with the screwdriver while lifting upward on the air cleaner to release it from the stock grommets as shown.

NOTE: K&N Engineering, Inc., recommends that customers do not discard factory air intake.

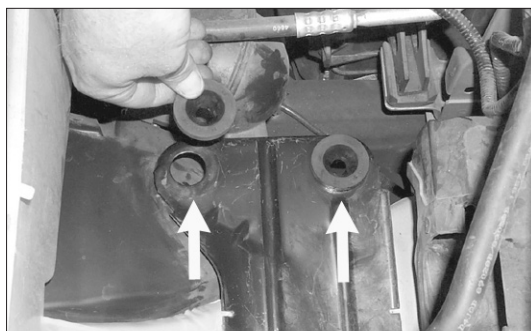

11. Remove the stock grommets from the air cleaner tray.



12. Remove the mass air sensor from the air cleaner cover as shown.



13. Install the provided edge trim onto the heat shield as shown.

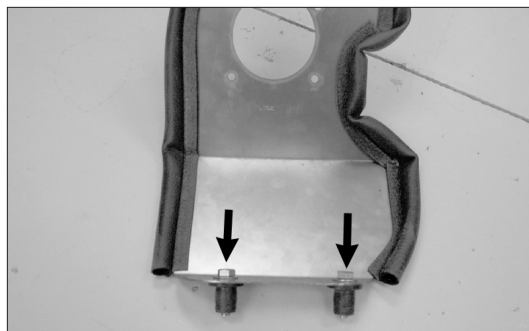

14. Install the hex bolts, washers, and rubber expansion nuts onto the heat shield as shown.

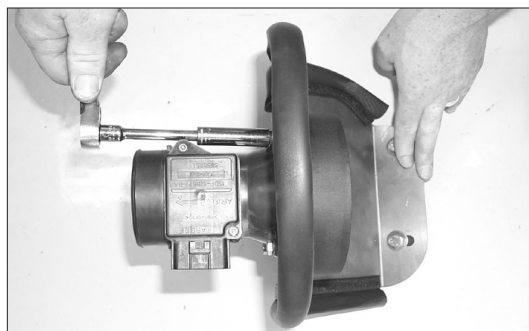

15. Assemble the mass air adapter, gaskets, heat shield and stock mass air sensor using the provided hardware as shown.



16. Install the heat shield assembly and line up the rubber expansion nuts into the holes on the air cleaner tray but do not tighten at this time.



17. Install the silicone hose and hose clamps onto the throttle body and tighten as shown.



18. Install the silicone hose and hose clamps onto the mass air sensor and tighten as shown.



19. Slide the intake tube into the silicone hose at the throttle body and at the mass air sensor, adjust for best fit and tighten as shown.



20. Tighten the hex bolts on the heat shield as shown.

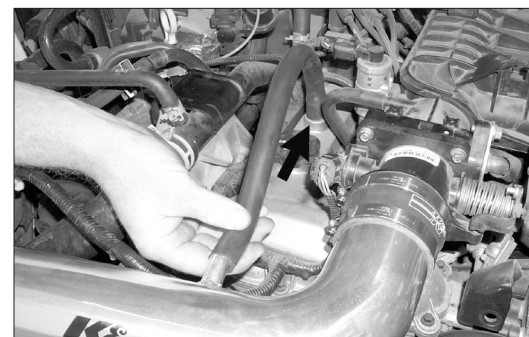

21. Install the provided silicone hose onto the vent on the cam cover, then, connect the other end to the vent on the intake tube as shown.



22. Squeeze the filter as shown and slide the filter into the inner fender as shown.



23. Slide the filter onto the mass air adapter and secure with the provided hose clamp as shown.

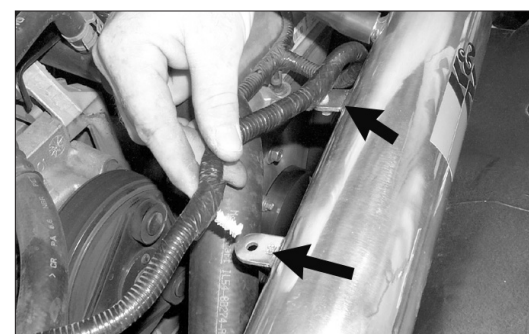

24. Insert the wire harness push clips into the tabs on the K&N® intake tube as shown.

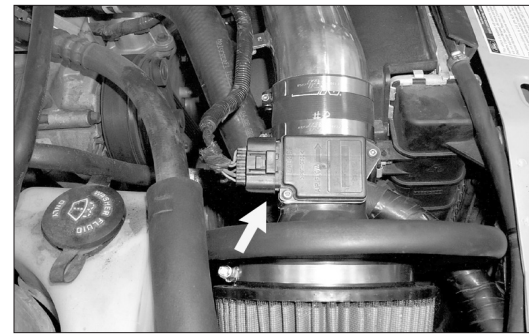

25. Reconnect the mass air sensor electrical connection as shown.



26. Using the provided zip-tie secure the air conditioning hard line and the coolant overflow hose to the inner fender as shown.



27. Install the throttle body cover and secure with the stock bolts as shown.

28. Reconnect the vehicle's negative battery cable. Double check to make sure everything is tight and properly positioned before starting the vehicle.

29. The C.A.R.B. exemption sticker, (attached), must be visible under the hood so that an emissions inspector can see it when the vehicle is required to be tested for emissions. California requires testing every two years, other states may vary.

30. It will be necessary for all K&N® high flow intake systems to be checked periodically for realignment, clearance and tightening of all connections. Failure to follow the above instructions or proper maintenance may void warranty.

ROAD TESTING:

1. Start the engine with the transmission in neutral or park, and the parking brake engaged. Listen for air leaks or odd noises. For air leaks secure hoses and connections. For odd noises, find cause and repair before proceeding. This kit will function identically to the factory system except for being louder and much more responsive.

2. Test drive the vehicle. Listen for odd noises or rattles and fix as necessary.

3. If road test is fine, you can now enjoy the added power and performance from your kit.

4. K&N Engineering, Inc., suggests checking the air filter element periodically for excessive dirt build-up. When the element becomes covered in dirt (or once a year), service it according to the instructions on the Recharger® service kit, part number 99-5050 or 99-5000.

INTAKE SYSTEMS FOR VEHICLES LISTED ARE 50 STATE LEGAL. SEE KNFILTERS.COM FOR CARB STATUS ON EACH PART FOR A SPECIFIC VEHICLE.