



INTAKE SYSTEMS FOR VEHICLES LISTED ARE 50 STATE LEGAL. SEE KNFILTERS.COM FOR CARB STATUS ON EACH PART FOR A SPECIFIC VEHICLE.

INSTALLATION INSTRUCTIONS

77-6016KS NISSAN 2008-12 Pathfinder V8-5.6L

NOTE: This kit was not designed to fit vehicles with a body lift.

TOOLS NEEDED:

- 3mm Allen Wrench
- 4mm Allen Wrench
- 10mm Socket
- 13mm Socket
- 10mm Wrench
- Extension
- Flat Blade Screwdriver
- Phillips Screwdriver
- Pliers
- Ratchet
- Tape Measure

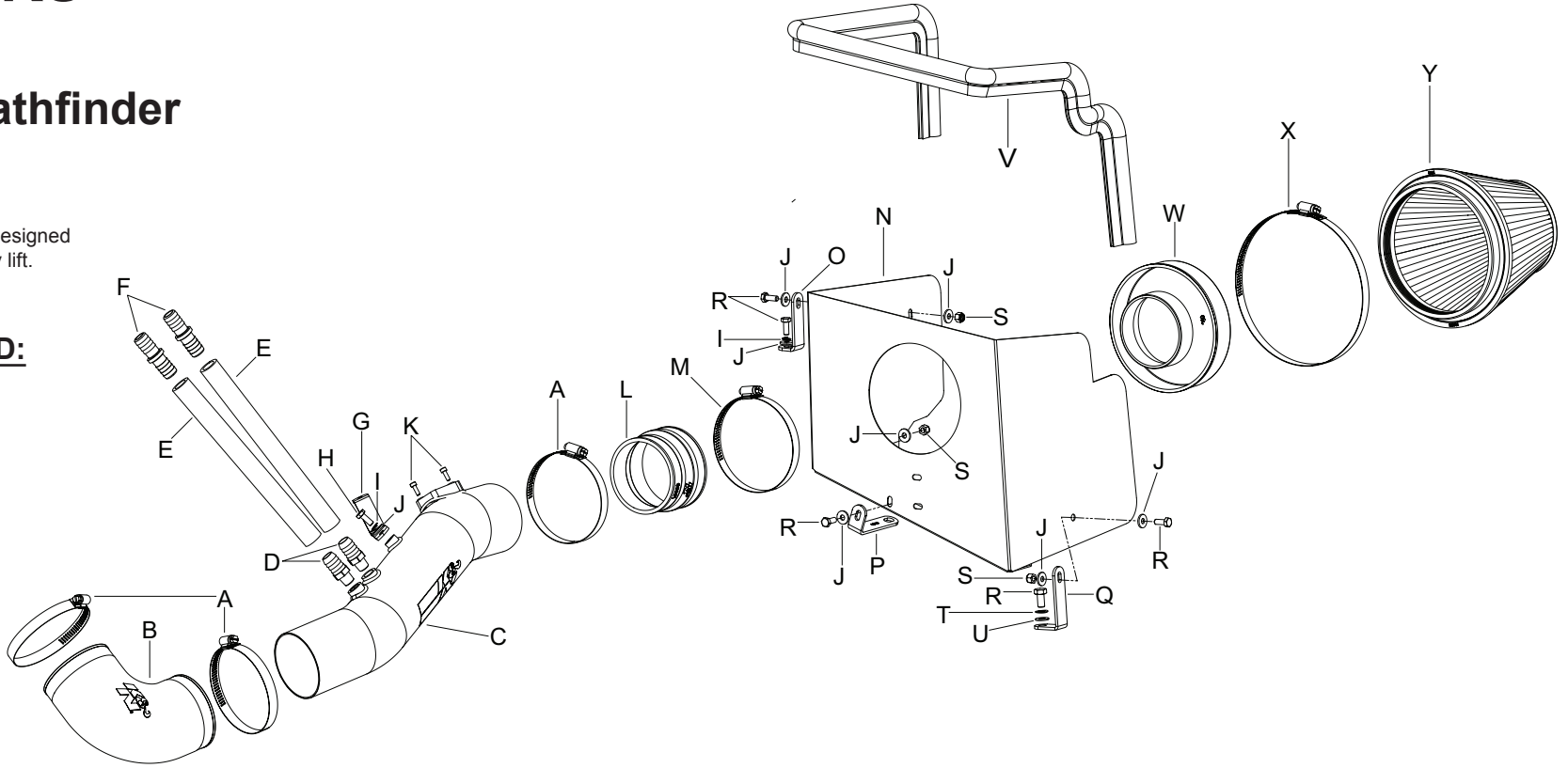

PARTS LIST:

Description	Qty.	Part #
A Hose Clamp #52	3	08610
B Hose; 3-1/4"ID, 90° Elbow, Blk. Silicone	1	084095
C Intake Tube	1	27552
D Vent; Strt., 5/8 Barbed 1/4 NPT, Nylon	2	08911
E Hose; 5/8"ID x 9-3/4"L, Blk. Silicone	1	084047
F Vent; Strt., 5/8" Hose - 5/8" Hose	2	08048
G Bracket; "Z", Mild Stl., FB/PC	1	07191
H Bolt; 8MM-1.25 x 16MM, Hex Head	1	07844
I Washer; 1/4" Lock, ZN	2	08198
J Washer; 1/4"ID x 5/8"OD - SAE	8	08275
K Bolt; M4 - 0.07 8mm, A/H CAP, SS	2	07733
L Hose; 3.5"ID to 3.25"ID, Tprd., Silicone	1	08051
M Hose Clamp #56	1	08620
N Heat Shield	1	07689
O Bracket; "L"	1	07805
P Bracket; "L" Stl, TK/PC	1	010051
Q Bracket; "L", Fin.	1	070632
R Bolt; 6mm-1.00 x 16mm, SS	5	07812
S Nut; 6mm Nylock, Hex Head, SS	3	07512
T Washer; 5/16"ID x 5/8"OD, Flat	1	08276
U Washer; 8mm spring (Wave)	1	08239
V Edge trim (44")	1	102486
W Adaptor; #380	1	21512-1
X Hose Clamp #104	1	08697
Y Air Filter	1	RC-4381

NOTE: FAILURE TO FOLLOW INSTALLATION INSTRUCTIONS AND NOT USING THE PROVIDED HARDWARE MAY DAMAGE THE INTAKE TUBE, THROTTLE BODY AND ENGINE.

TO START:

- Turn off the ignition and disconnect the negative battery cable.
NOTE: Disconnecting the negative battery cable erases pre-programmed electronic memories. Write down all memory settings before disconnecting the negative battery cable. Some radios will require an anti-theft code to be entered after the battery is reconnected. The anti-theft code is typically supplied with your owner's manual. In the event your vehicles' anti-theft code cannot be recovered, contact an authorized dealership to obtain your vehicles anti-theft code.



- Disconnect the mass air sensor electrical connection and unclip the wiring harness from the airbox.



- Remove the two bolts which secure the engine cover to the engine.



- Lift the engine cover and dislodge it from the mounting grommets and then remove the engine cover from the engine.

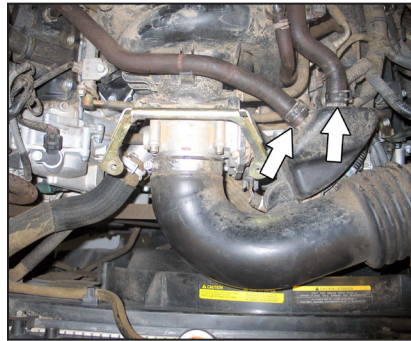

- Release the two spring clamps which secure the crankcase vent hoses to the intake tube and then disconnect the crankcase vent hoses from the intake tube.

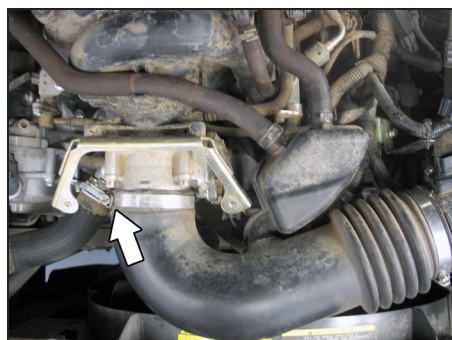

- Loosen the hose clamp which secures the intake tube to the throttle body.



- Remove the bolt shown which secures the airbox to the inner fender.



- Remove the complete intake assembly from the vehicle as shown.
NOTE: K&N Engineering, Inc., recommends that customers do not discard factory air intake.

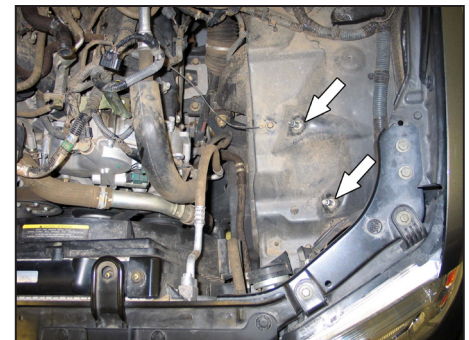

- Remove the two airbox mounting studs shown from the inner fender.

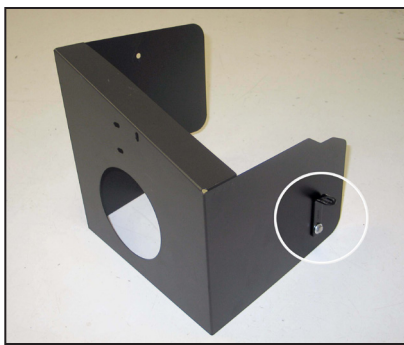

10. Install the heat shield mounting bracket (07805) onto the heat shield as shown using the provided hardware.

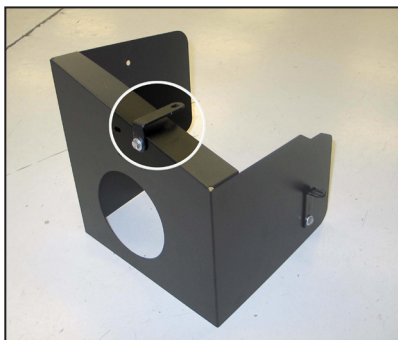

11. Install the heat shield mounting bracket (010051) onto the heat shield as shown using the provided hardware.

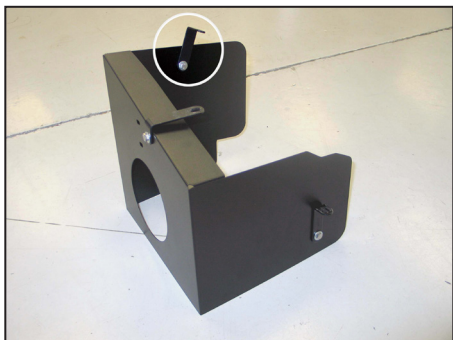

12. Install the heat shield mounting bracket (070632) onto the heat shield as shown using the provided hardware.



13. Install the provided edge trim onto the heat shield as shown.
NOTE: Some trimming of the edge trim will be necessary.



14. Remove the ground strap mounting bolt shown.
NOTE: this bolt will be reused in the next step.



15. Install the heat shield assembly into position and secure with the provided hardware and the bolt removed in the previous step.
NOTE: Be sure to place the ground strap between the heat shield mounting bracket and inner fender.

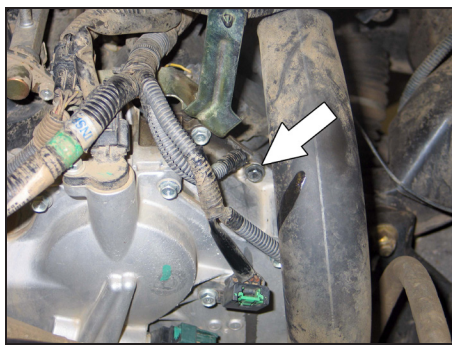

16. Remove the engine ground strap mounting bolt shown.

NOTE: This bolt will be reused in the next step.



17. Install the tube mounting bracket (07191) onto the engine and secure with the factory bolt removed in the previous step.

NOTE: Be sure to place the ground strap between the bracket and engine.



18. Install the provided silicone hose (084095) onto the throttle body and secure with the provided hose clamp.

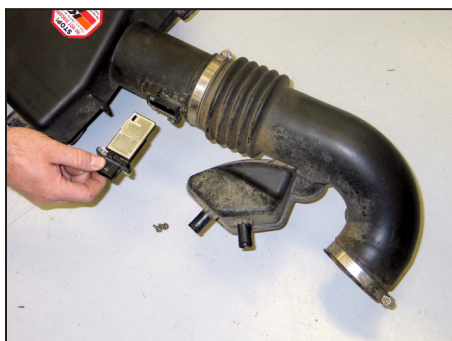

19. Remove the mass air sensor from the stock intake tube as shown.



20. Install the mass air sensor into the K&N intake tube and secure with the provided hardware.



21. Install the provided silicone hose (08051) onto the K&N intake tube as shown and secure with the provided hose clamp.

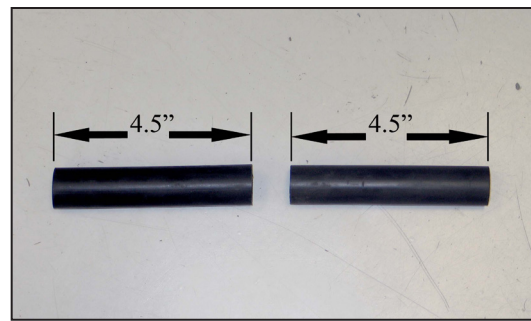

22. Cut the provided crankcase vent hose into two 4.5" sections as shown.

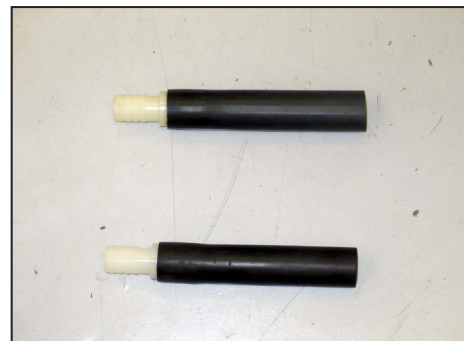

23. Install the two provided hose menders into the each of the crankcase vent hose sections as shown.



24. Install the two 1/4 NPT crankcase vent fittings into the K&N intake tube as shown.

NOTE: Plastic NPT fittings are easy to cross thread. Install the vent fitting "hand" tight, then turn it two complete turns with a wrench.



25. Attach the two modified crankcase hoses onto the 1/4 NPT fittings.



26. Install the K&N intake tube assembly and secure to the mounting bracket and silicone hose with the provided hardware and hose clamp. Then connect the crankcase vent hoses to the factory hoses as shown.



27. Install the filter adapter into the K&N air filter and secure with the provided hose clamp.
NOTE: Drycharger air filter wrap; part # RF-1036DK is available to purchase separately. To learn more about Drycharger filter wraps or look up color availability please visit <http://www.knfilters.com>.

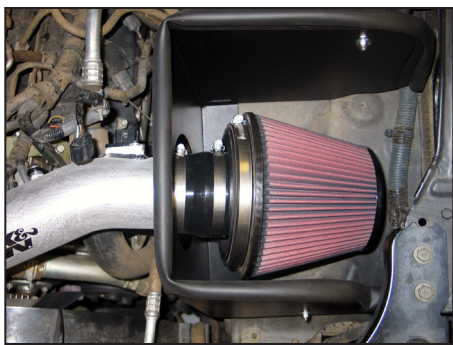

28. Install the filter assembly onto the K&N® intake tube and secure with the provided hose clamp.



29. Reconnect the mass air sensor electrical connection.



30. Reinstall the engine cover and secure with the factory bolts.



31. Reconnect the vehicle's negative battery cable. Double check to make sure everything is tight and properly positioned before starting the vehicle.

32. The C.A.R.B. exemption sticker, (attached), must be visible under the hood so that an emissions inspector can see it when the vehicle is required to be tested for emissions. California requires testing every two years, other states may vary.

33. It will be necessary for all K&N® high flow intake systems to be checked periodically for realignment, clearance and tightening of all connections. Failure to follow the above instructions or proper maintenance may void warranty.

ROAD TESTING:

1. Start the engine with the transmission in neutral or park, and the parking brake engaged. Listen for air leaks or odd noises. For air leaks secure hoses and connections. For odd noises, find cause and repair before proceeding. This kit will function identically to the factory system except for being louder and much more responsive.

2. Test drive the vehicle. Listen for odd noises or rattles and fix as necessary.

3. If road test is fine, you can now enjoy the added power and performance from your kit.

4. K&N Engineering, Inc., requires cleaning the intake system's air filter element every 100,000 miles. When used in dusty or off-road environments, our filters will require cleaning more often. We recommend that you visually inspect your filter once every 25,000 miles to determine if the screen is still visible. When the screen is no longer visible some place on the filter element, it is time to clean it. To clean and re-oil, purchase our filter Recharger® service kit, part number 99-5050 or 99-5000 and follow the easy instructions.

INTAKE SYSTEMS FOR VEHICLES LISTED ARE 50 STATE LEGAL. SEE KNFILTERS.COM FOR CARB STATUS ON EACH PART FOR A SPECIFIC VEHICLE.