



AP-309157 (INSTALLATION INSTRUCTIONS FOR 05+ TACOMA BED COMPRESSOR BOX, KITS AP-308373, AP-309027, AND AP-309028)

	NOTICE Read instructions completely before installing this product. Refer back to the instructions frequently during installation.
-----------------------------------------------------------------------------------	----------------------------------------------------------------------------------------------------------------------------------------------

	CAUTION Flying Object Hazard. Fluid Splash Hazard. Wear safety glasses at all times when working on vehicle.
------------------------------------------------------------------------------------	------------------------------------------------------------------------------------------------------------------------------

	WARNING: Cancer and Reproductive Harm - www.P65Warnings.ca.gov
-----------------------------------------------------------------------------------	-------------------------------------------------------------------------------------------------------------------

1. Remove the (6) screws holding the factory bed storage box to the inside of the bed. Remove the bed storage box.



2. If you are installing the AP steel door, install the cam latches or locks provided with the kit into the cutouts in the door. The latches should be installed on the side with the bent tabs as shown.



AP-309157



3. If you are retaining your original bed box bezel and door, measure 1/2" from the base of the factory box as shown. Extend a line between the measured points around the box. Using a cutoff wheel trim the box along the line. Cut off the (2) plastic alignment tabs on the back side of the bezel as shown in the picture.

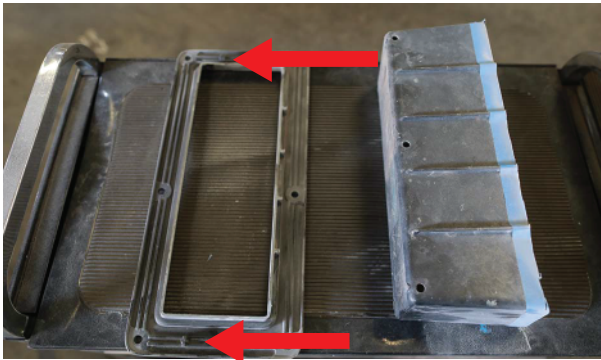
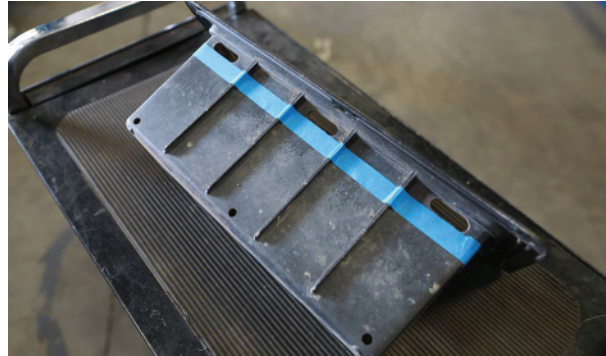

4. If applicable, install the new AP bezel pieces. The piece with the larger holes should go directly against the side of the bed around the threaded inserts. The piece with the smaller holes should be installed between the first piece and the head of the mounting screws. Use the original mounting screws to secure the bezel pieces to the bed. Otherwise reinstall the trimmed factory bed box bezel using the original screws.





5. If applicable, test fit the new AP door. If there is excess play between the latches and the bezel pieces bend the latch arm towards the door. If there is not enough clearance between the latch arm and the bezel pieces (latches won't close) bend the piece away from the door.

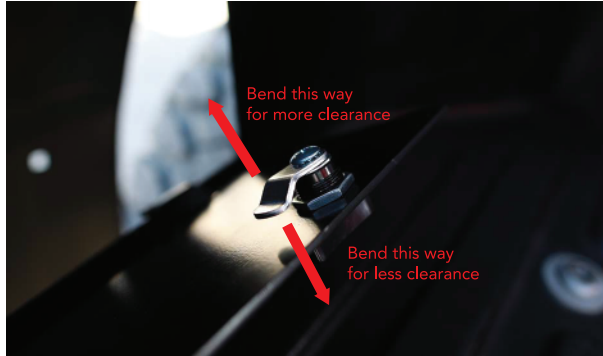

6. If applicable, install the ARB rocker switch provided with your ARB compressor through one of the rectangular holes in the bed box. If you are using one of AP's extended compressor harnesses you can mount a rocker switch in the box, the cab, or both to control the compressor in the box. Note, the switches are independent of one another so the compressor can be turned on even if the other switch is in the "OFF" position. The side of the box you install your switch should also be the side of the box through which you route the wiring harness for the ARB compressor. The compressor wiring harness and rocker switch can be installed on either the front or rear of the box. Install the provided rectangular plug in the hole that is not used.



7. If applicable, install the ARB compressor into the box using the existing mounting holes.

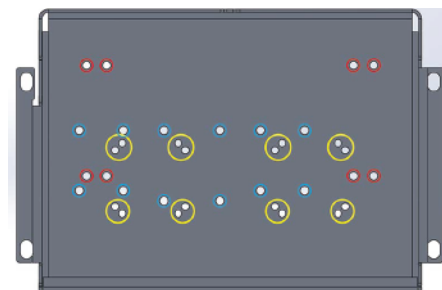

Red = ARB Manifold Mntg. Holes (ARB-171503)
Blue = ARB-CKMTA12/24
Yellow = ARB-CKSA12, ARB-CKMA12

8. If applicable, slide the compressor wiring harness through the slots in the front or rear of the box. Make sure that the end of the wiring harness with mating connectors for your compressor is installed into the box. If you are unsure which end of the harness connects to your compressor consult the wiring diagrams at the end of these instructions. Install the split grommet over the wiring harness loom and snap it into the holes in the side of the box. Install the provided round plug into the unused hole.



9. Connect the necessary connectors of the wiring harness to the connectors on the compressor or locker solenoids. Route the wires for the rocker switch back out of the box through the installed grommet and connect the wires to the appropriate terminals of the rocker switch.

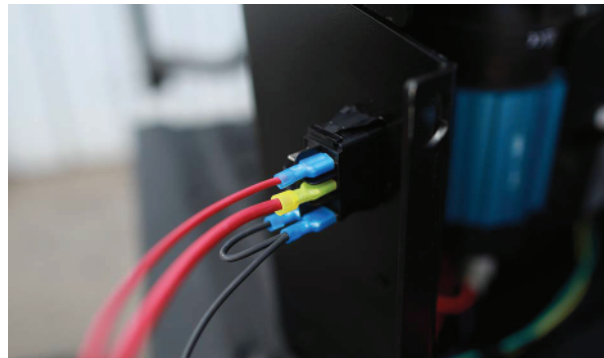

10. Using the provided tape, cover any unused mounting holes in the box. Leave the bottom corner holes open so any moisture that enters the box can drain out the holes.

11. Before installing the compressor box it may be necessary to remove the rear driver inner fender liner from the wheel well to allow easier access to the box mounting bolts. After enough access has been achieved, install the compressor box onto the screws that are sticking through the side of the bed. Note the box has oversized mounting holes that slide over the threaded inserts in the side of the bed. Once the box is flush against the side of the bed over the threaded inserts, install the provided spacers and lock nuts on to the (2) front and (2) rear screws. Orient the flats in the spacers to go along the side of the box closest to the bend. Tighten the lock nuts onto the mounting screws. The upper rear lock nut will need to be tightened through the cutout on the inside of the box.



12. Once the box is secure, route the wiring harness along the driver frame rail, if applicable. Secure the wiring harness about every 12" using zip ties to sturdy mounting points. Route the harness away from moving parts which create pinch points, heat sources like the exhaust, and away from direct exposure to debris when driving. We routed the wiring harness behind the two heat shields around the exhaust tube on the driver side of the engine and then up into the engine bay along the brake lines shown.



13. Once the harness is in the engine bay, connect the appropriate terminals of the harness to a power source (keyed or un-keyed) and the existing ARB switch harness that you plan on using. Reference the wiring diagram at the end of these instructions if you are unsure which connections to make.

14. If you plan on mounting compressor or locker switches inside the cab of the truck, feed the necessary connector through the gland on the firewall below the brake booster and wire the appropriate ARB switches in the cab according to the appropriate wiring diagram from ARB. We found it helpful to use a small, stiff wire with the connector taped to it in order to get through the gland.

15. With power running to the compressor switch(s), test the switches to make sure the compressor turns on at the appropriate time. Remember, if you wired (2) switches to the same compressor, as long as both are getting power they operate independently of one another and either one can turn the compressor on.



AP-308461

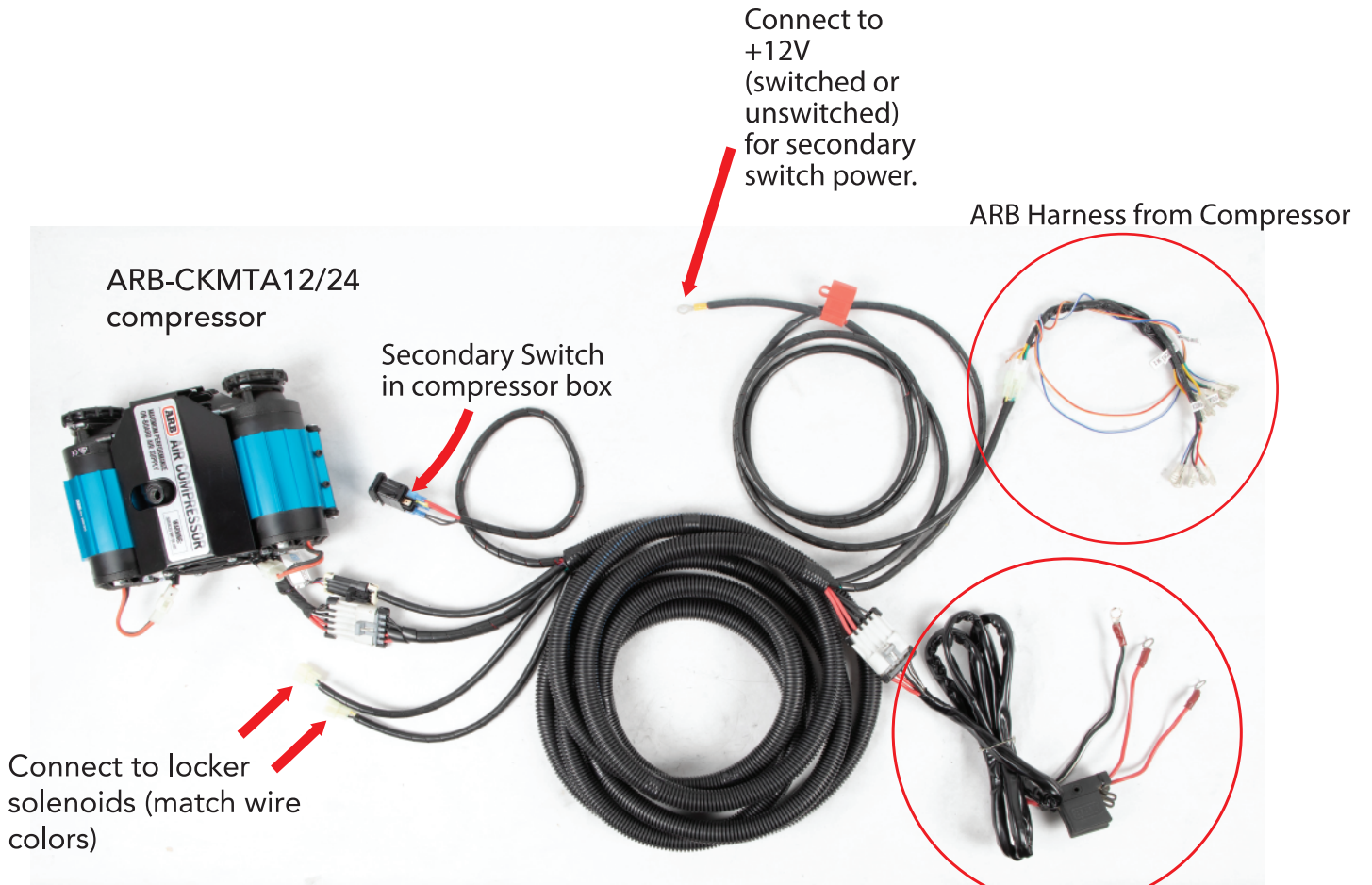

* wire ARB harnesses per ARB compressor manual.

ARB Harness from Compressor



AP-308461

Connect to pressure switch connector on compressor

Connect (2) black wires to switch to switch pins 7&8. Connect thin gauge red wire to switch pin 3. Connect thick gauge red wire to switch pin 2.

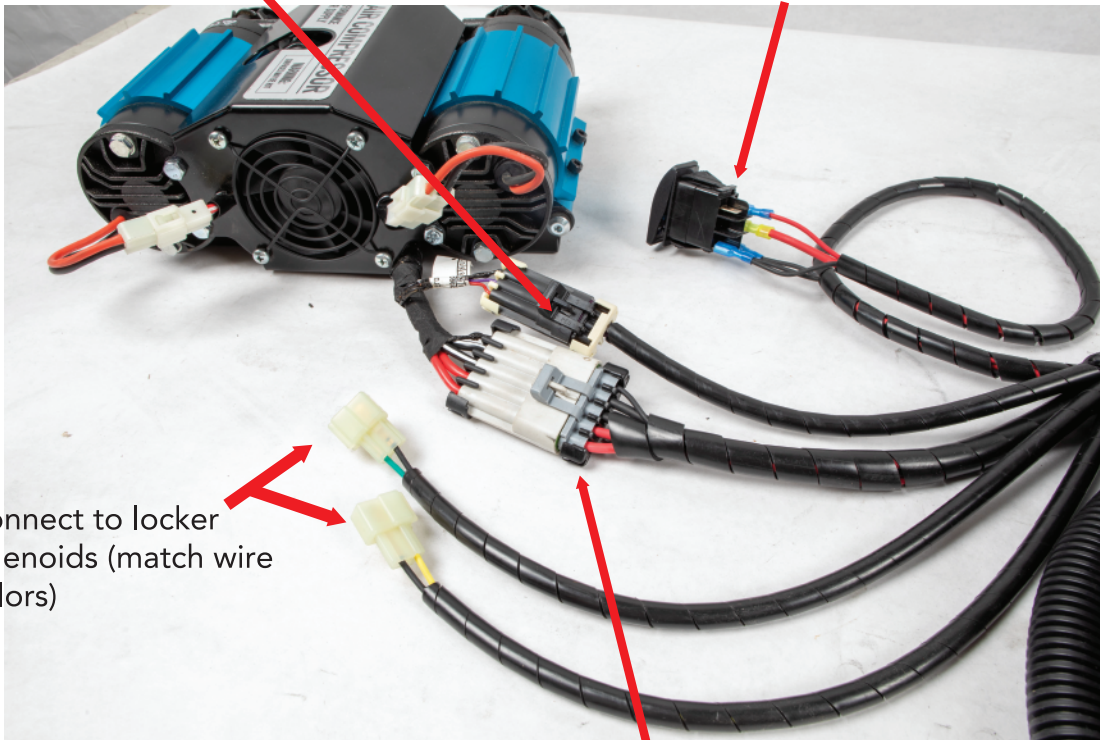

Connect to locker solenoids (match wire colors)

Connect to compressor power connector on compressor



AP-308461

Connect to +12V
(switched or unswitched)
for secondary switch
power

Connect to ARB switch
harness supplied with
compressor

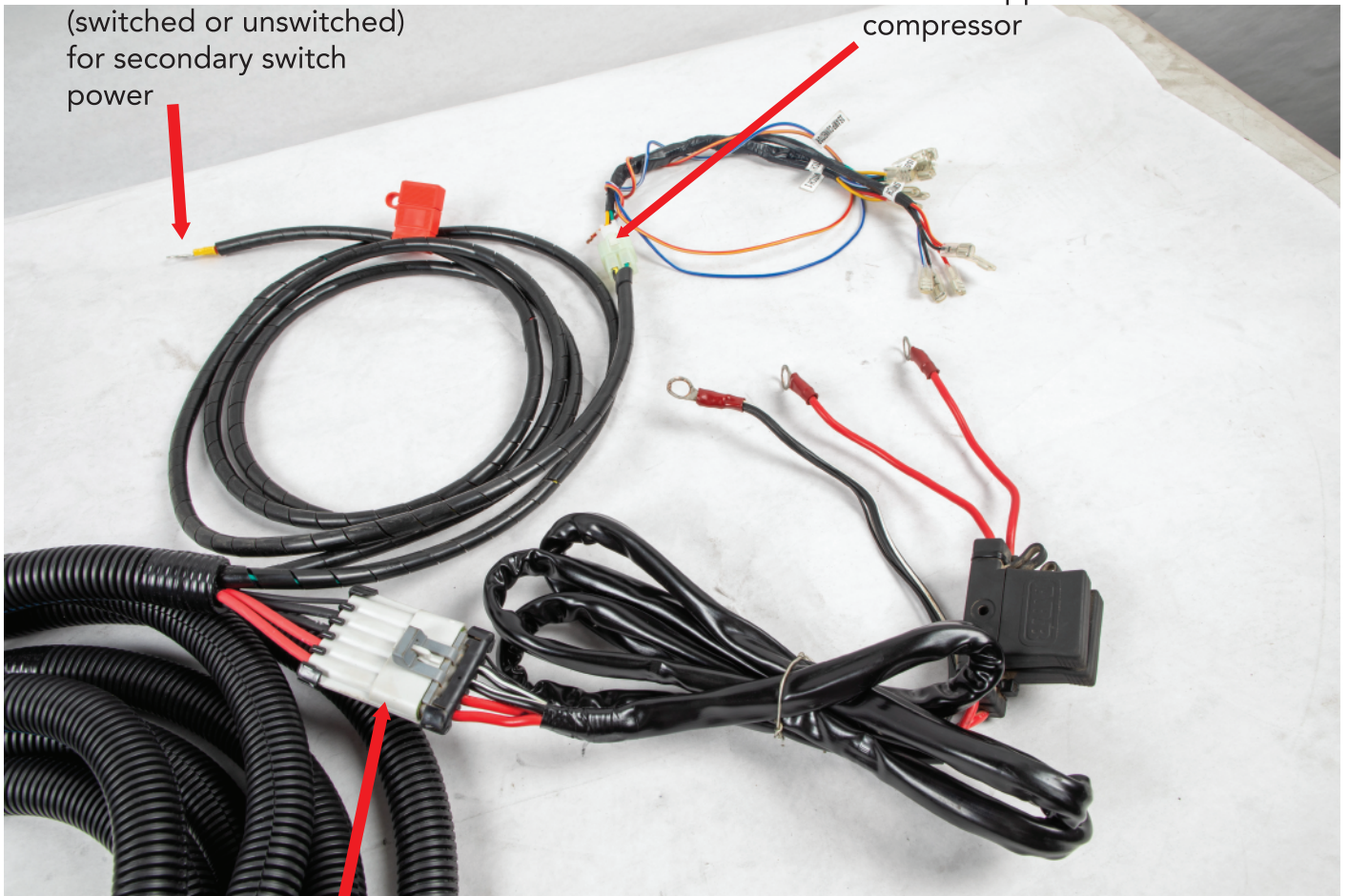

Connect to ARB power
harness supplied w/
compressor



AP-308463

ARB Harness from Compressor

ARB-CKSA12 compressor

ARB Harness from Compressor

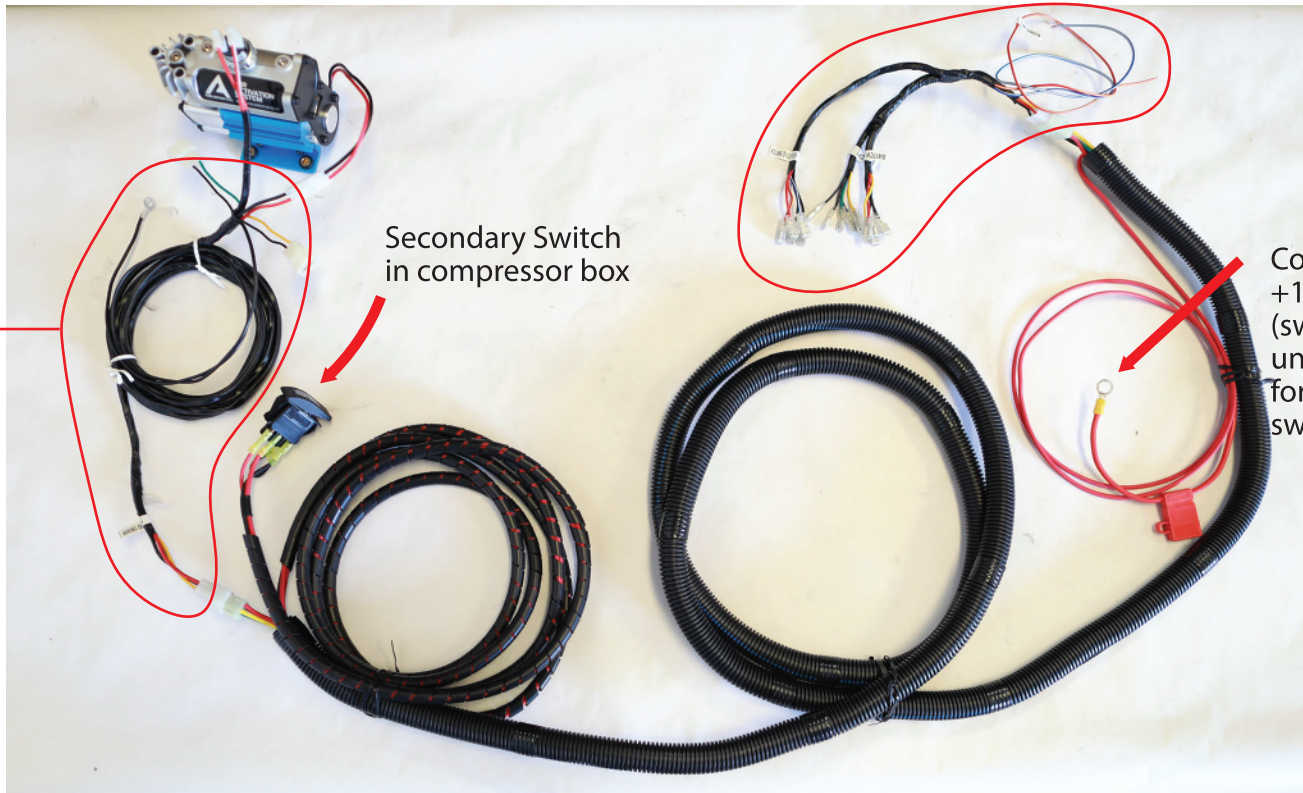

Secondary Switch
in compressor box

Connect to
+12V
(switched or
unswitched)
for secondary
switch power.

* wire ARB harnesses per
ARB compressor manual.



AP-308463

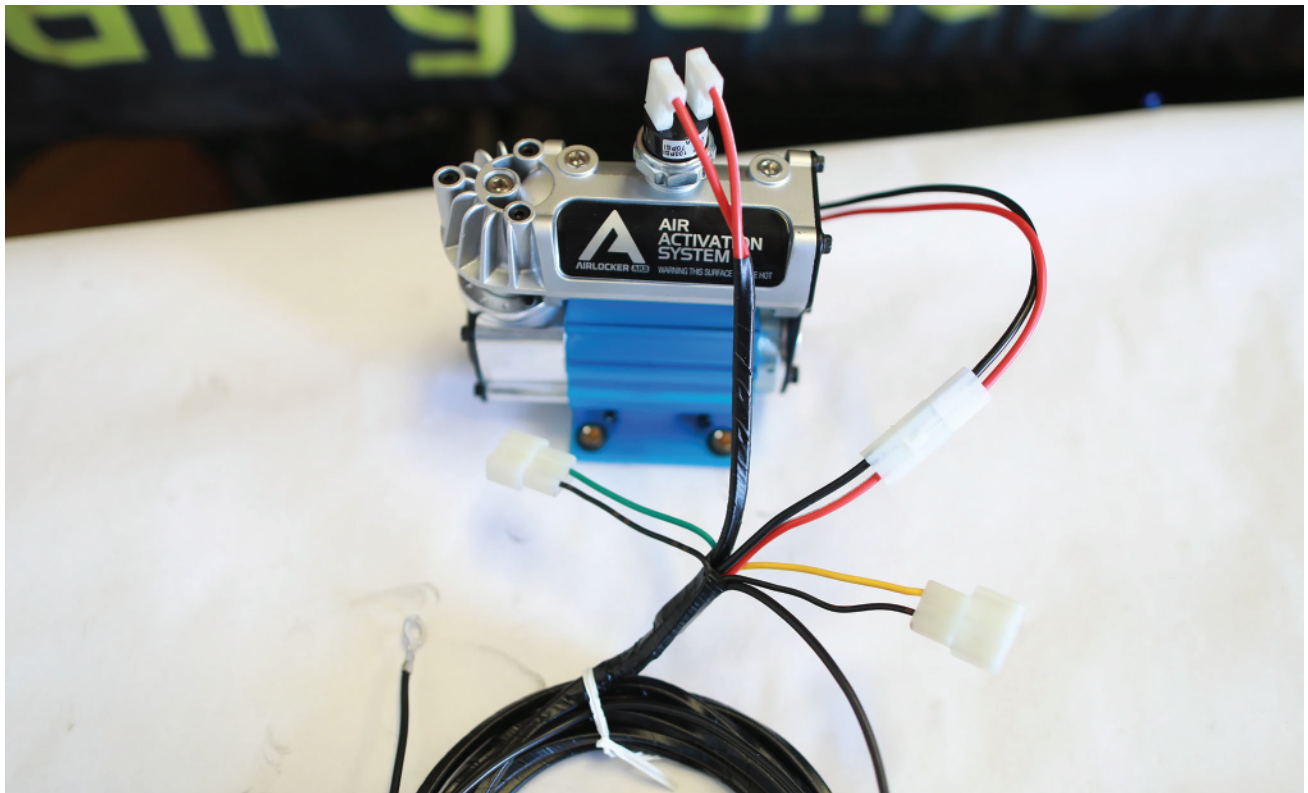

wire per ARB compressor
documentation.



AP-308463

Secondary Compressor Switch In Box

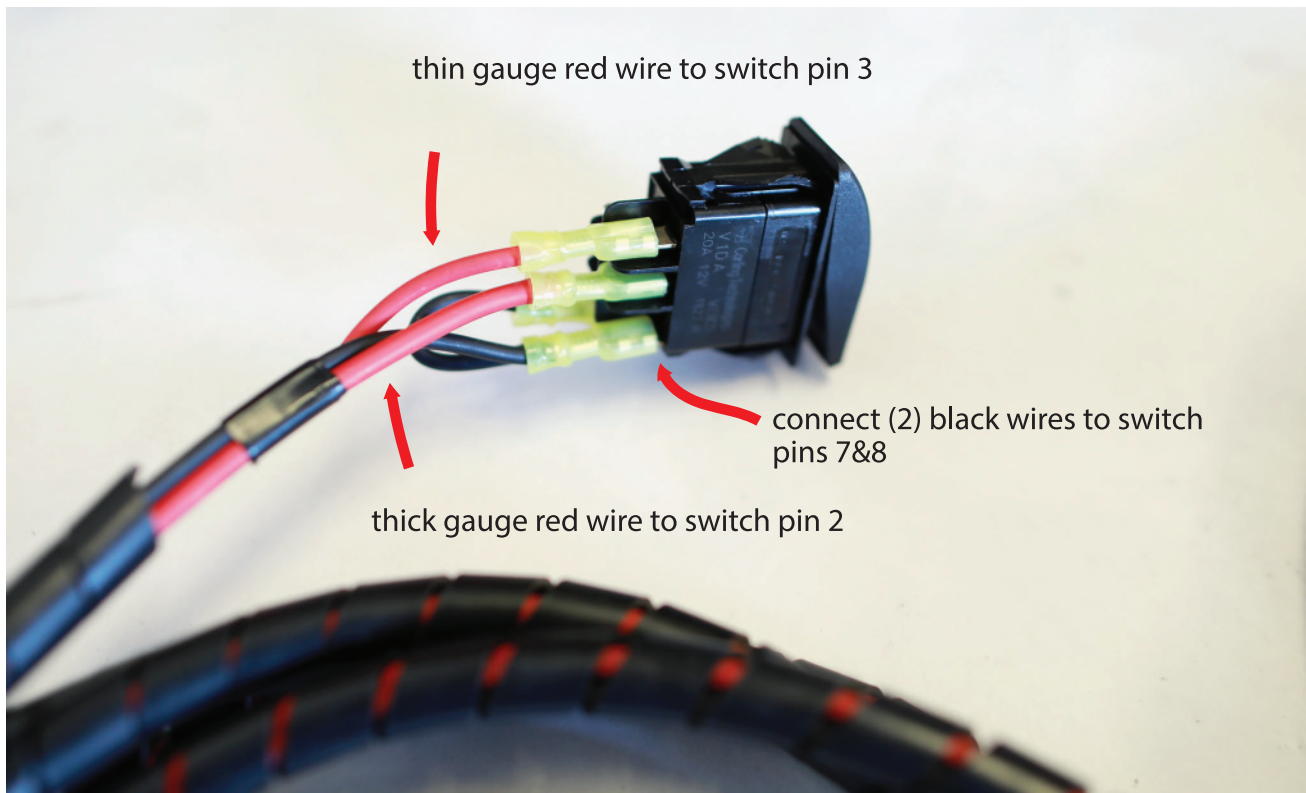



AP-308464

ARB-CKMA12/24
Compressor

Connect to +12V (switched
or unswitched) for
secondary switch power

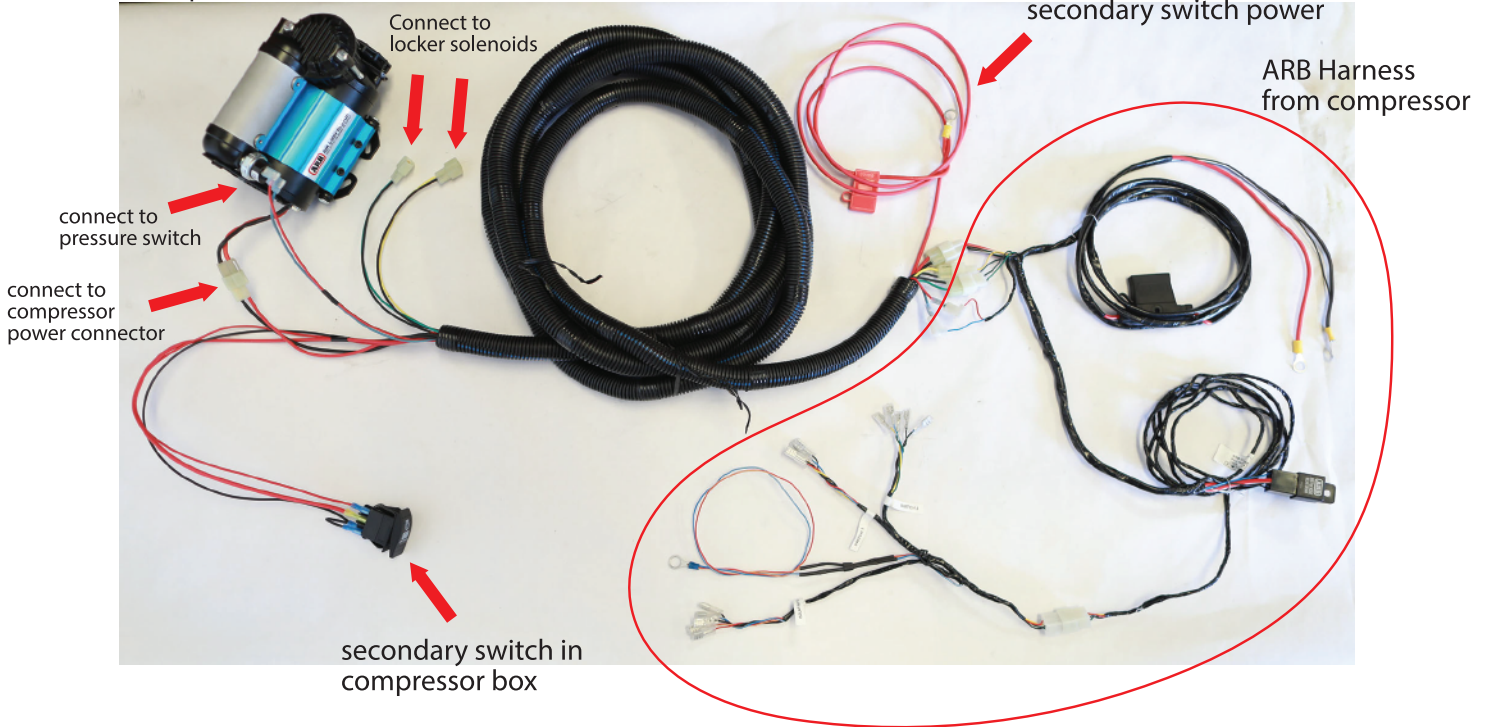

* wire ARB harnesses per
ARB compressor manual.



AP-308464

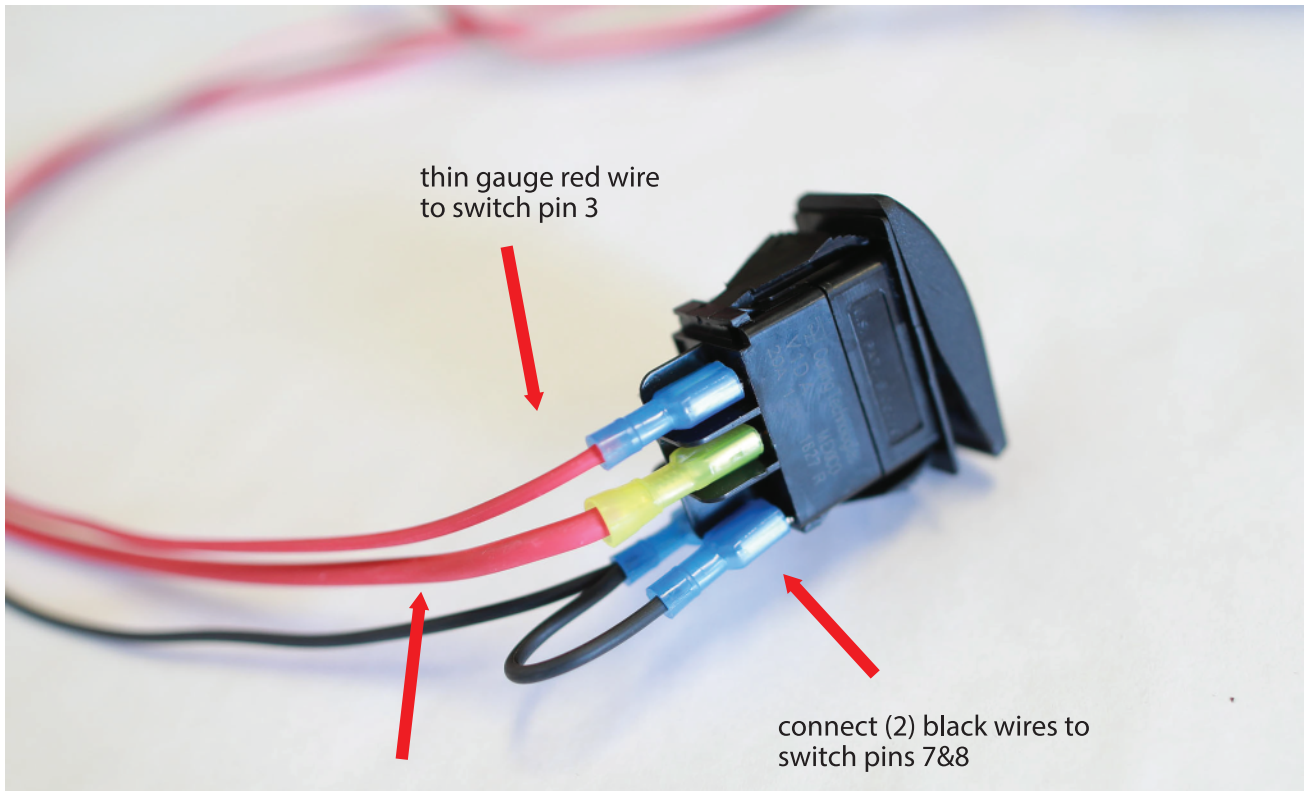

thick gauge red wire to
switch pin 2



AP-308464

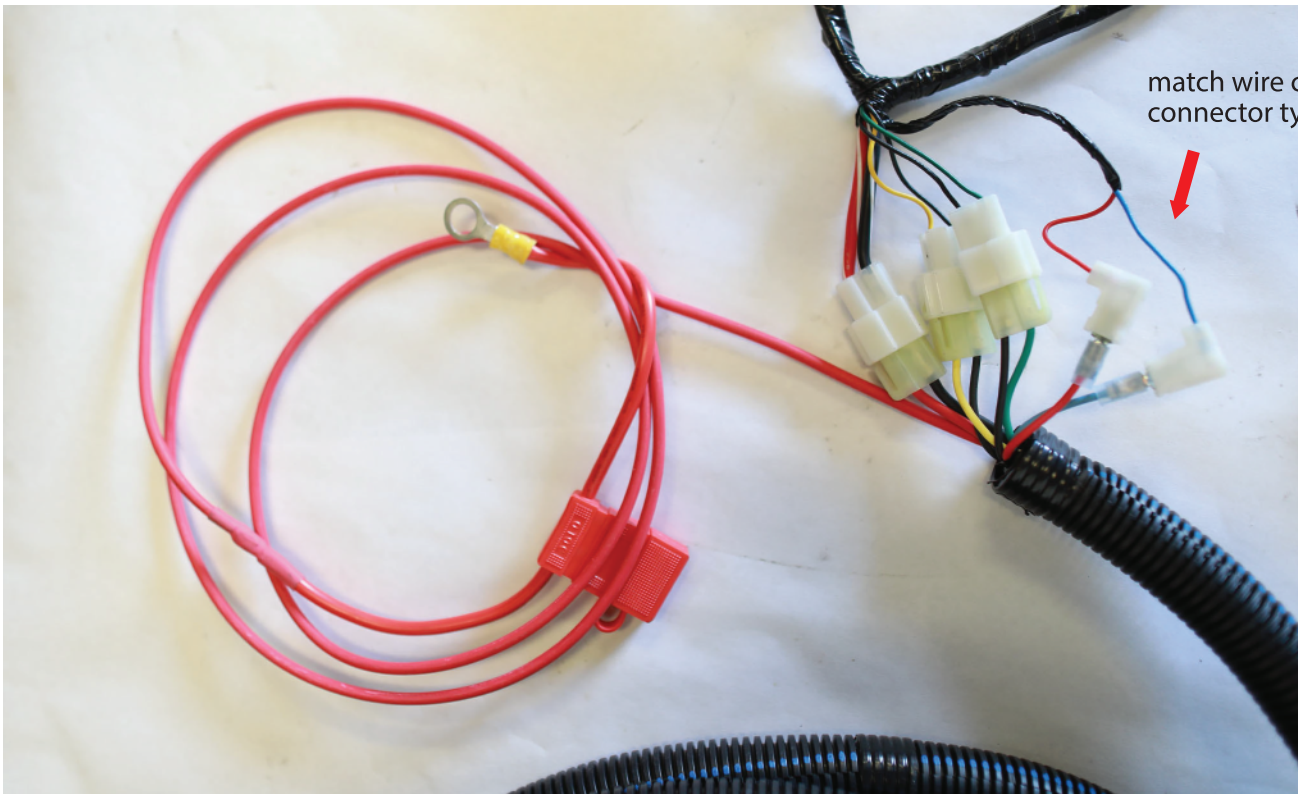

match wire colors &
connector types