

Installation Instructions

18-19 Jeep Wrangler
JL Unlimited

IS-26631_RevA



For proper installation and best possible fit, please read all instructions BEFORE you begin.
For technical assistance or to obtain missing parts, please call Customer Relations at 1-800-328-2409

Important Safety Information



- CAUTION - Before driving, ensure that the steps are properly secured to vehicle.
- Periodically check all components for tightness.

Contents

NOTE: Actual product may vary from illustration.



Left Step



Right Step



8mm x 35mm Bolt (6)



8mm Lock Washer(6)



8mm Flat Washer(6)



6mm x 25mm Bolt (12)



6mm Flat Washer(24)



6mm Nylock Nut (12)

Tools Required



Socket Wrench



Socket (Set)

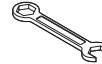

18mm Wrench



Safety glasses

Installation

1

Remove any Factory or aftermarket steps or rock rails present on the vehicle.

2

Start installation on the driver/left side of the vehicle.

Locate the (3) pairs of factory mounting holes along the pinch weld. **See Figure 1.**

The mounting brackets on the Rail Side Steps attach to the holes in the pinch weld and the small factory threaded hole directly behind the pinch weld. **See Figures 2 - 4**

Figure 1



Figure 2 FRONT

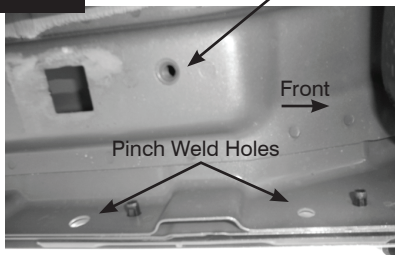

Figure 3 CENTER

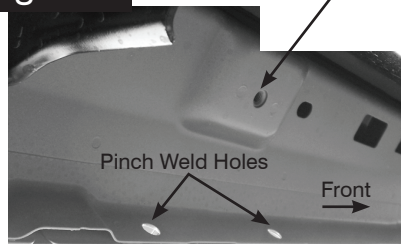
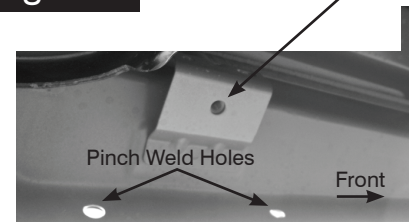

Figure 4 REAR



3

Identify the driver/left side step.

The front mount has a cleared opening.

See Figure 5

Figure 5 DRIVER/LEFT FRONT MOUNT

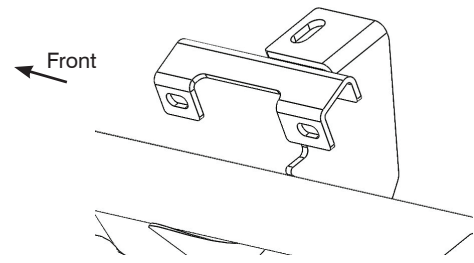

4

With assistance, hold the Driver/left Rail Side Steps up in place against the back of the pinch weld. Line up the (3) welded brackets with the (6) factory holes in the pinch weld. Bolt the brackets to the back of the pinch weld with the included (6) 6mm x 25mm Hex Bolts, (12) 6mm Flat Washers and (6) 6mm Nylon Lock Nuts.

Leave hardware loose at this time.

NOTE: Insert Bolts from outside the pinch weld and out through the Bracket.

Then bolt each top tab on the Trail Crawler Step to the vehicle with the included (1) 8mm x 35mm Hex Bolt, (1) 8mm Lock Washer and (1) 8mm Flat Washer.

Leave hardware loose at this time.

See Figures 6 - 8.

Figure 6 DRIVER/LEFT FRONT MOUNT

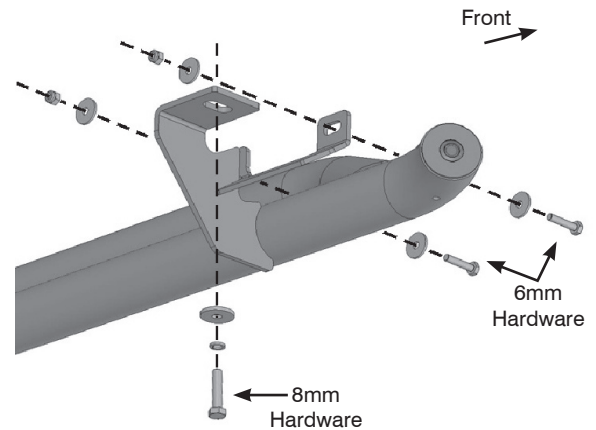
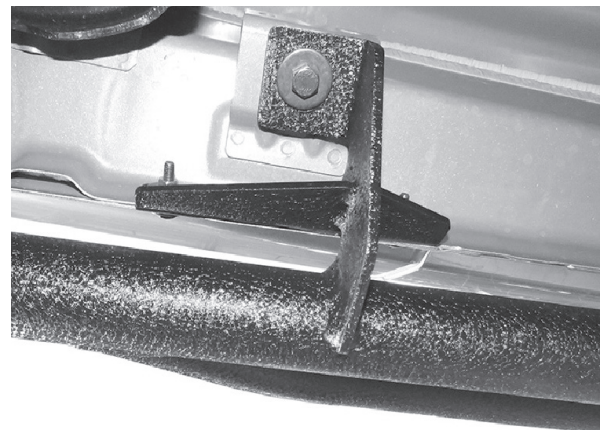

Figure 7 DRIVER/LEFT FRONT MOUNT



Figure 8 DRIVER/LEFT REAR MOUNT



5

Level and adjust steps on the vehicle and tighten all hardware.



6

Repeat all instruction steps on opposite side.

Care and Cleaning

- Rampage products are built to last; any detergent you use to wash your vehicle is sufficient to clean the bumper. Do not use any harsh abrasive detergents. Periodically check and lubricate moving parts.

Congratulations!

You have purchased one of the many quality Rampage branded products offered by Lund International. We take the utmost pride in our products and want you to enjoy years of satisfaction from your investment. We have made every effort to ensure that your product is top quality in terms of fit, durability, finish and ease of installation.



The material that your product is made from can be recycled. Please also consider recycling the packaging that your product came in.



800-328-2409 • Visit us at Rampageproducts.com
© 2018 Lund Motion Products, Inc. All rights reserved.
Rampage Products™ is a trademark of Lund Motion Products, Inc.



Instructions d'installation

18-19 Jeep
Wrangler JL
Unlimited 4 Dr
All Sub-Models

IS-26631_RevA



Rail Side Step

Pour une installation correcte et un ajustement optimal, veuillez lire toutes les instructions AVANT de commencer.

Pour obtenir une assistance technique ou pour obtenir des pièces manquantes, veuillez appeler le service à la clientèle au 1-800-328-2409.

Informations de sécurité importantes



- ATTENTION - Avant de conduire, assurez-vous que les marches sont correctement fixées au véhicule.
- Vérifiez régulièrement que tous les composants sont bien serrés.

Contenu

REMARQUE: Le produit réel peut différer de l'illustration.



Pas de gauche



Bonne étape



8mm x 35mm
Boulon (6)



8mm Rondelle De
Verrouillage (6)



Rondelle plate
8mm (6)



6mm x 25mm
Boulon (12)



Rondelle plate
de 6mm (24)



Écrou Nylock
6mm (12)

Outils nécessaires

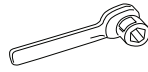

Clé à douille



ensemble de Prise

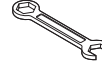

ensemble de
clé



Lunettes de
protection

Installation

1

Retirez toutes les marches d'usine ou de rechange ou les garde-fous présents sur le véhicule.

2

Commencer l'installation sur le côté conducteur / gauche du véhicule.

Localisez les (3) paires de trous de montage en usine le long de la soudure par pincement. **Voir la figure 1.**

Les supports de montage des marchepieds latéraux du rail sont fixés aux trous de la soudure par pincement et au petit trou fileté en usine situé directement derrière la soudure par pincement. **Voir les figures 2 à 4**

Figure 1



Figure 2 AVANT

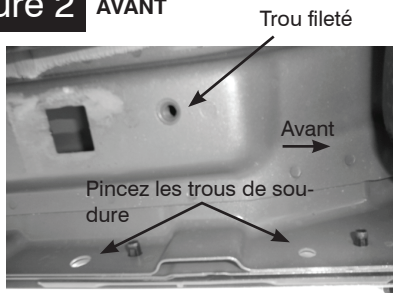

Figure 3 CENTRE

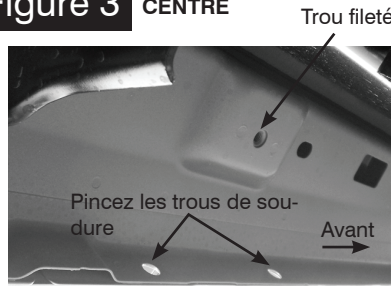
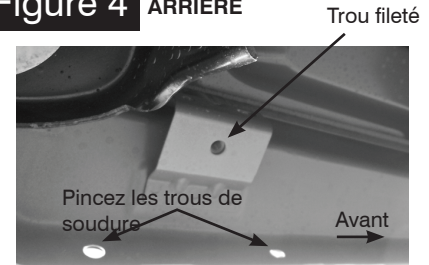

Figure 4 ARRIÈRE



3

Identifiez le pas du conducteur / côté gauche.

Le montage avant a une ouverture dégagée.

Voir la figure 5

Figure 5 CONDUCTEUR / AVANT GAUCHE

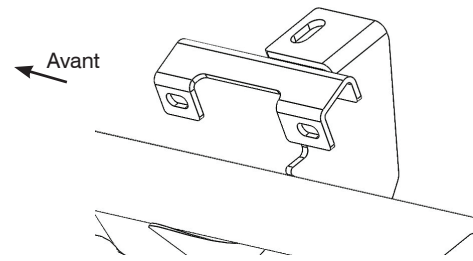

4

Avec de l'aide, tenez les marches du côté conducteur / rail gauche en place contre l'arrière de la soudure pincée. Alignez les (3) supports soudés avec les (6) trous d'usine dans la soudure à pincement. Boulonner les supports au dos de la soudure par pincement avec les (6) boulons hexagonaux de 6 mm x 25 mm fournis, (12) rondelles plates de 6 mm et (6) écrous de blocage en nylon de 6 mm.

Laisser le matériel lâche en ce moment.

REMARQUE: Insérez les boulons de l'extérieur de la soudure par pincement et sortez-les par le support.

Ensuite, vissez chaque patte supérieure du Trail Crawler Step sur le véhicule à l'aide du (1) boulon à tête hexagonale de 8 mm x 35 mm, de la (1) rondelle de blocage de 8 mm et de la (1) rondelle plate de 8 mm.

Laisser le matériel lâche en ce moment.

Voir les figures 6 à 8.

Figure 6 CONDUCTEUR / AVANT GAUCHE

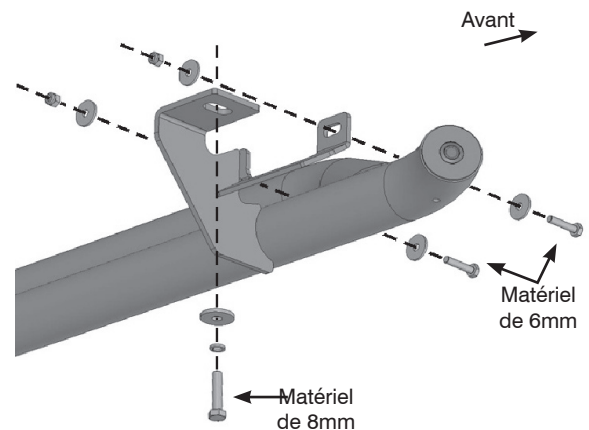
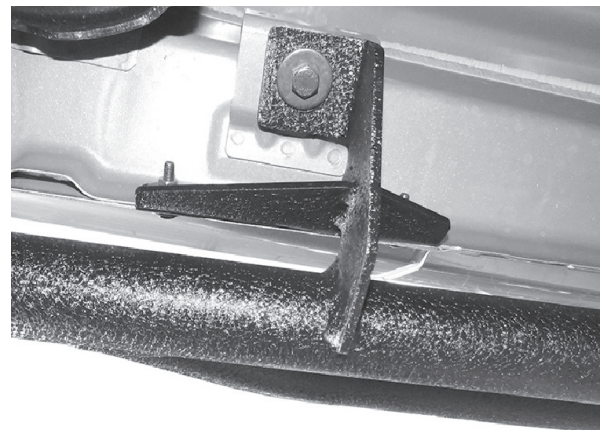

Figure 7 CONDUCTEUR / AVANT GAUCHE



Figure 8 CONDUCTEUR / SUPPORT ARRIÈRE GAUCHE



5

Nivelez et ajustez les marches du véhicule et serrez tout le matériel.



6

Répétez toutes les étapes de l'instruction du côté opposé.

Care and Cleaning

- Les produits de rampe sont conçus pour durer; tout détergent que vous utilisez pour laver votre véhicule est suffisant pour nettoyer le pare-chocs. N'utilisez pas de détergents abrasifs durs. Contrôler et lubrifier périodiquement les pièces en mouvement.

Félicitations

Vous avez acheté l'un des nombreux produits de qualité Rampage proposés par Lund International. Nous tirons une grande fierté de nos produits et souhaitons que vous profitiez de nombreuses années de votre investissement. Nous nous sommes efforcés de garantir la qualité supérieure de votre produit en termes d'ajustement, de durabilité, de finition et de facilité d'installation.



Le matériau à partir duquel votre produit est fabriqué peut être recyclé. Veuillez également envisager de recycler l'emballage dans lequel votre produit est entré.



800-328-2409 • Rendez-vous sur Rampageproducts.com

© 2018 Lund Motion Products, Inc. Tous droits réservés.

Rampage Products™ est une marque commerciale de Lund Motion Products, Inc.



Instrucciones de instalación

18-19 Jeep
Wrangler JL
Unlimited 4 Dr
All Sub-Models

IS-26631_RevA



Rail Side Step

Para una instalación adecuada y el mejor ajuste posible, lea todas las instrucciones ANTES de comenzar.
Para asistencia técnica o para obtener piezas faltantes, llame a Atención al Cliente al 1-800-328-2409.

Información de Seguridad Importante



- PRECAUCIÓN: antes de conducir, asegúrese de que los pasos estén correctamente asegurados al vehículo.
- Verifique periódicamente que todos los componentes estén apretados.

Contenido

NOTA: El producto real puede variar de la ilustración.



Paso izquierdo



Paso derecho



Perno de 8 mm x 35 mm (6)



Arandela de seguridad de 8 mm (6)



Arandela plana de 8 mm (6)



Perno de 6 mm x 25 mm (12)



Lavadora plana de 6 mm (24)



Tuerca Nylock de 6 mm (12)

Herramientas necesarias



Llave de tubo



Juego de dados

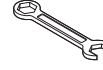

Juego de llaves



Lentes de seguridad

Instalación

1

Elimine los pasos de fábrica o de posventa o los rieles de roca presentes en el vehículo.

2

Comience la instalación en el conductor / lado izquierdo del vehículo.

Ubique los (3) pares de orificios de montaje de fábrica a lo largo de la soldadura pellizcada. Ver la **Figura 1**.

Los soportes de montaje en los Pasos laterales del riel se unen a los orificios de la soldadura por presión y al pequeño orificio roscado de fábrica directamente detrás de la soldadura por presión. Ver **Figuras 2 - 4**

Figura 1



Figura 2 FRENTE



Figura 3 CENTRO



Figura 4 POSTERIOR

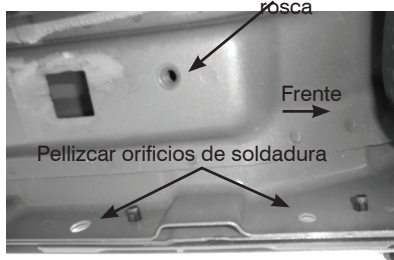

3

Identifique el paso del conductor / lado izquierdo.

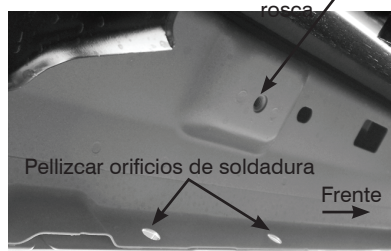
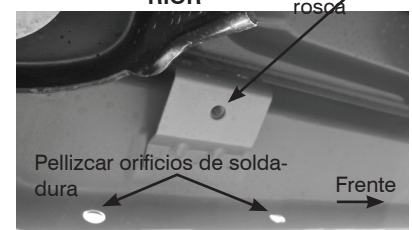
El montaje frontal tiene una abertura separada.

Ver la Figura 5

Con ayuda, sostenga el Controlador / Pasos laterales del riel izquierdo hacia arriba en su

4

lugar contra la parte posterior de la soldadura pellizcada. Alinee los (3) soportes soldados con los (6) orificios de fábrica en la soldadura pellizcada. Atornille los soportes a la parte posterior de la soldadura por presión con los (6) pernos hexagonales de 6 mm x 25 mm, (12) arandelas planas de 6 mm y (6) tuercas de seguridad de nylon de 6 mm.

Deje el hardware suelto en este momento.

NOTA: Inserte los pernos desde el exterior de la soldadura pellizcada y hacia fuera a través del soporte.

A continuación, atornille cada lengüeta superior del escalón Trail Crawler al vehículo con el (1) perno hexagonal de 8 mm x 35 mm incluido (1), (1) arandela de seguridad de 8 mm y (1) arandela plana de 8 mm.

Deje el hardware suelto en este momento.

Ver Figuras 6 - 8.

Figura 5 CONDUCTOR / MONTAJE DELANTERO IZQUIERDO

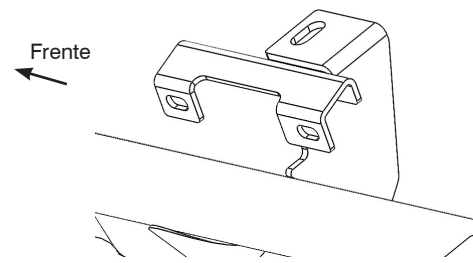

Figure 6 CONDUCTOR / MONTAJE DELANTERO IZQUIERDO



Figura 7 CONDUCTOR / MONTAJE DELANTERO IZQUIERDO



Figura 8 CONDUCTOR / MONTAJE POSTERIOR IZQUIERDO

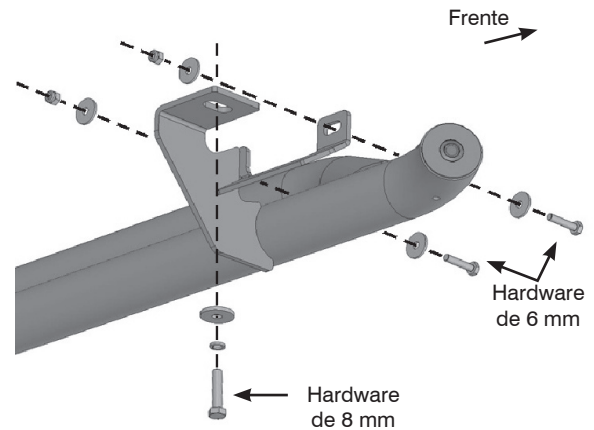
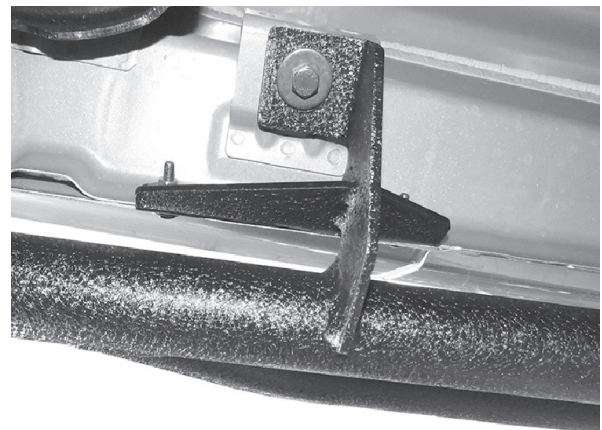

5

Nivele y ajuste los pasos en el vehículo y apriete todo el hardware.



6

Repita todos los pasos de instrucción en el lado opuesto.

Cuidado y Limpieza

- Los productos Rampage están diseñados para durar; cualquier detergente que use para lavar su vehículo es suficiente para limpiar el parachoques. No use detergentes abrasivos fuertes. Controle y lubrique periódicamente las piezas móviles.

¡Felicidades!

Usted ha comprado uno de los muchos productos de calidad Rampage ofrecidos por Lund International. Nos enorgullecemos de nuestros productos y queremos que disfrute años de satisfacción de su inversión. Hemos hecho todos los esfuerzos posibles para garantizar que su producto sea de alta calidad en términos de ajuste, durabilidad, acabado y facilidad de instalación.



El material del que está hecho su producto puede reciclarse. Considere también reciclar el embalaje en el que entró su producto.



800-328-2409 • Visítanos en Rampageproducts.com
© 2018 Lund Motion Products, Inc. Todos los derechos reservados.
Rampage Products™ es una marca registrada de Lund Motion Products, Inc.

